

8. WASTE HEAT RECOVERY

Syllabus

Waste Heat Recovery: Classification, Advantages and applications, Commercially viable waste heat recovery devices, Saving potential.

8.1 Introduction

Waste heat is heat, which is generated in a process by way of fuel combustion or chemical reaction, and then “dumped” into the environment even though it could still be reused for some useful and economic purpose. The essential quality of heat is not the amount but rather its “value”. The strategy of how to recover this heat depends in part on the temperature of the waste heat gases and the economics involved.

Large quantity of hot flue gases is generated from Boilers, Kilns, Ovens and Furnaces. If some of this waste heat could be recovered, a considerable amount of primary fuel could be saved. The energy lost in waste gases cannot be fully recovered. However, much of the heat could be recovered and loss minimized by adopting following measures as outlined in this chapter.

Heat Losses – Quality

Depending upon the type of process, waste heat can be rejected at virtually any temperature from that of chilled cooling water to high temperature waste gases from an industrial furnace or kiln. Usually higher the temperature, higher the quality and more cost effective is the heat recovery. In any study of waste heat recovery, it is absolutely necessary that there should be some use for the recovered heat. Typical examples of use would be preheating of combustion air, space heating, or pre-heating boiler feed water or process water. With high temperature heat recovery, a cascade system of waste heat recovery may be practiced to ensure that the maximum amount of heat is recovered at the highest potential. An example of this technique of waste heat recovery would be where the high temperature stage was used for air pre-heating and the low temperature stage used for process feed water heating or steam raising.

Heat Losses – Quantity

In any heat recovery situation it is essential to know the amount of heat recoverable and also how it can be used. An example of the availability of waste heat is given below:

- **Heat recovery from heat treatment furnace**

In a heat treatment furnace, the exhaust gases are leaving the furnace at 900 °C at the rate of 2100 m³/hour. The total heat recoverable at 180°C final exhaust can be calculated as

$$Q = V \times \rho \times C_p \times \Delta T$$

Q is the heat content in kCal

V is the flowrate of the substance in m³/hr

ρ is density of the flue gas in kg/m^3

C_p is the specific heat of the substance in $\text{kCal/kg } ^\circ\text{C}$

ΔT is the temperature difference in $^\circ\text{C}$

C_p (Specific heat of flue gas) = $0.24 \text{ kCal/kg/}^\circ\text{C}$

Heat available (Q) = $2100 \times 1.19 \times 0.24 \times ((900-180)) = 4,31,827 \text{ kCal/hr}$

By installing a recuperator, this heat can be recovered to pre-heat the combustion air. The fuel savings would be 33% (@ 1% fuel reduction for every 22°C reduction in temperature of flue gas).

8.2 Classification and Application

In considering the potential for heat recovery, it is useful to note all the possibilities, and grade the waste heat in terms of potential value as shown in the following Table 8.1:

TABLE 8.1 WASTE SOURCE AND QUALITY		
S.No.	Source	Quality
1.	Heat in flue gases.	The higher the temperature, the greater the potential value for heat recovery
2.	Heat in vapour streams.	As above but when condensed, latent heat also recoverable.
3.	Convective and radiant heat lost from exterior of equipment	Low grade – if collected may be used for space heating or air preheats.
4.	Heat losses in cooling water.	Low grade – useful gains if heat is exchanged with incoming fresh water
5.	Heat losses in providing chilled water or in the disposal of chilled water	a) High grade if it can be utilized to reduce demand for refrigeration. b) Low grade if refrigeration unit used as a form of heat pump.
6.	Heat stored in products leaving the process	Quality depends upon temperature.
7.	Heat in gaseous and liquid effluents leaving process.	Poor if heavily contaminated and thus requiring alloy heat exchanger.

High Temperature Heat Recovery

The following Table 8.2 gives temperatures of waste gases from industrial process equipment in the high temperature range. All of these results from direct fuel fired processes.

Medium Temperature Heat Recovery

The following Table 8.3 gives the temperatures of waste gases from process equipment in the medium temperature range. Most of the waste heat in this temperature range comes from the exhaust of directly fired process units.

TABLE 8.2 TYPICAL WASTE HEAT TEMPERATURE AT HIGH TEMPERATURE RANGE FROM VARIOUS SOURCES	
Types of Device	Temperature, °C
Nickel refining furnace	1370–1650
Aluminium refining furnace	650–760
Zinc refining furnace	760–1100
Copper refining furnace	760–815
Steel heating furnaces	925–1050
Copper reverberatory furnace	900–1100
Open hearth furnace	650–700
Cement kiln (Dry process)	620–730
Glass melting furnace	1000–1550
Hydrogen plants	650–1000
Solid waste incinerators	650–1000
Fume incinerators	650–1450

TABLE 8.3 TYPICAL WASTE HEAT TEMPERATURE AT MEDIUM TEMPERATURE RANGE FROM VARIOUS SOURCES	
Type of Device	Temperature, °C
Steam boiler exhausts	230–480
Gas turbine exhausts	370–540
Reciprocating engine exhausts	315–600
Reciprocating engine exhausts (turbo charged)	230–370
Heat treating furnaces	425–650
Drying and baking ovens	230–600
Catalytic crackers	425–650
Annealing furnace cooling systems	425–650

Low Temperature Heat Recovery

The following Table 8.4 lists some heat sources in the low temperature range. In this range it is usually not practical to extract work from the source, though steam production may not be completely excluded if there is a need for low-pressure steam. Low temperature waste heat may be useful in a supplementary way for preheating purposes.

TABLE 8.4 TYPICAL WASTE HEAT TEMPERATURE AT LOW TEMPERATURE RANGE FROM VARIOUS SOURCES	
Source	Temperature, °C
Process steam condensate	55–88
Cooling water from:	
Furnace doors	32–55
Bearings	32–88
Welding machines	32–88
Injection molding machines	32–88
Annealing furnaces	66–230
Forming dies	27–88
Air compressors	27–50
Pumps	27–88
Internal combustion engines	66–120
Air conditioning and refrigeration condensers	32–43
Liquid still condensers	32–88
Drying, baking and curing ovens	93–230
Hot processed liquids	32–232
Hot processed solids	93–232

8.3 Benefits of Waste Heat Recovery

Benefits of 'waste heat recovery' can be broadly classified in two categories:

Direct Benefits:

Recovery of waste heat has a direct effect on the efficiency of the process. This is reflected by reduction in the utility consumption & costs, and process cost.

Indirect Benefits:

- a) **Reduction in pollution:** A number of toxic combustible wastes such as carbon monoxide gas, sour gas, carbon black off gases, oil sludge, Acrylonitrile and other plastic chemicals etc, releasing to atmosphere if/when burnt in the incinerators serves dual purpose i.e. recovers heat and reduces the environmental pollution levels.
- b) **Reduction in equipment sizes:** Waste heat recovery reduces the fuel consumption, which leads to reduction in the flue gas produced. This results in reduction in equipment sizes of all flue gas handling equipments such as fans, stacks, ducts, burners, etc.
- c) **Reduction in auxiliary energy consumption:** Reduction in equipment sizes gives additional benefits in the form of reduction in auxiliary energy consumption like electricity for fans, pumps etc..

8.4 Development of a Waste Heat Recovery System

Understanding the process

Understanding the process is essential for development of Waste Heat Recovery system. This can be accomplished by reviewing the process flow sheets, layout diagrams, piping isometrics, electrical and instrumentation cable ducting etc. Detail review of these documents will help in identifying:

- a) Sources and uses of waste heat
- b) Upset conditions occurring in the plant due to heat recovery
- c) Availability of space
- d) Any other constraint, such as dew point occurring in an equipments etc.

After identifying source of waste heat and the possible use of it, the next step is to select suitable heat recovery system and equipments to recover and utilise the same.

Economic Evaluation of Waste Heat Recovery System

It is necessary to evaluate the selected waste heat recovery system on the basis of financial analysis such as investment, depreciation, payback period, rate of return etc. In addition the advice of experienced consultants and suppliers must be obtained for rational decision.

Next section gives a brief description of common heat recovery devices available commercially and its typical industrial applications.

8.5 Commercial Waste Heat Recovery Devices

Recuperators

In a recuperator, heat exchange takes place between the flue gases and the air through metallic or ceramic walls. Duct or tubes carry the air for combustion to be pre-heated, the other side contains the waste heat stream. A recuperator for recovering waste heat from flue gases is shown in Figure 8.1.

The simplest configuration for a recuperator is the metallic radiation recuperator, which consists of two concentric lengths of metal tubing as shown in Figure 8.2.

The inner tube carries the hot exhaust gases while the external annulus carries the combustion air from the atmosphere to the air inlets of the furnace burners. The hot gases are cooled by the incoming combustion air which now carries additional energy into the combustion chamber. This is energy which does not have to be supplied by the fuel; consequently, less fuel is burned for a given furnace loading. The saving in fuel also means a decrease in combustion air and therefore

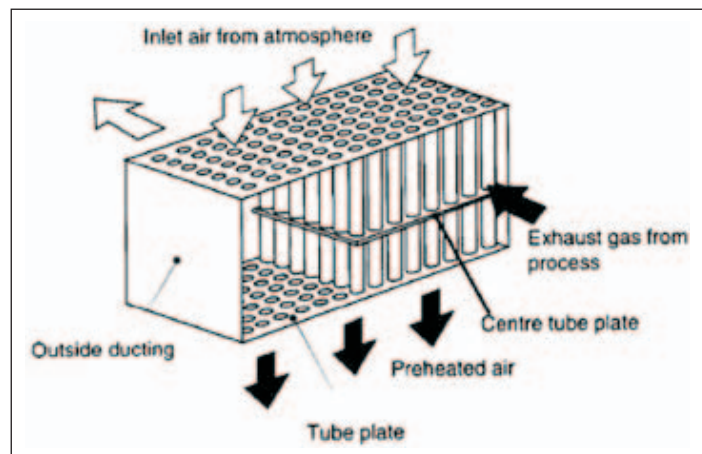

Figure 8.1 Waste Heat Recovery using Recuperator

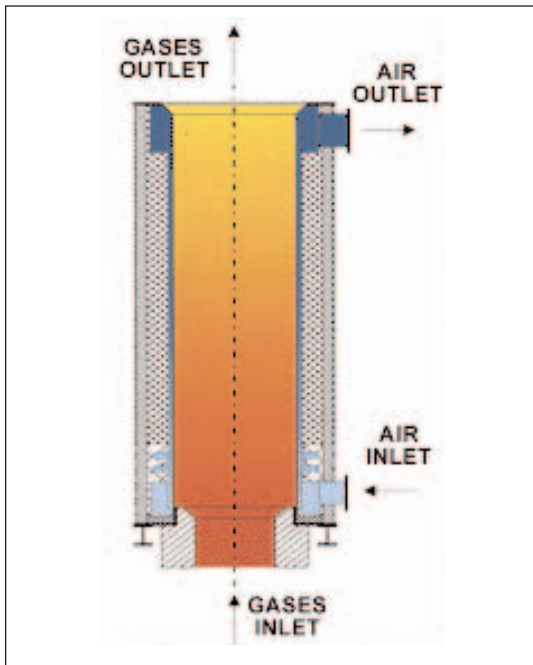

Figure 8.2 Metallic Radiation Recuperator

stack losses are decreased not only by lowering the stack gas temperatures but also by discharging smaller quantities of exhaust gas. The radiation recuperator gets its name from the fact that a substantial portion of the heat transfer from the hot gases to the surface of the inner tube takes place by radiative heat transfer. The cold air in the annuals, however, is almost transparent to infrared radiation so that only convection heat transfer takes place to the incoming air. As shown in the diagram, the two gas flows are usually parallel, although the configuration would be simpler and the heat transfer more efficient if the flows were opposed in direction (or counter-flow). The reason for the use of parallel flow is that recuperators frequently serve the additional function of cooling the duct carrying away the exhaust gases and consequently extending its service life.

A second common configuration for recuperators is called the tube type or convective recuperator. As seen in the figure 8.3, the hot gases are carried through a number of parallel small diameter tubes, while the incoming air to be heated enters a shell surrounding the tubes and passes over the hot tubes one or more times in a direction normal to their axes.

If the tubes are baffled to allow the gas to pass over them twice, the heat exchanger is termed a two-pass recuperator; if two baffles are used, a three-pass recuperator, etc. Although baffling increases both the cost of the exchanger and the pressure drop in the combustion air path, it increases the effectiveness of heat exchange. Shell and tube type recuperators are generally more compact and have a higher effectiveness than radiation recuperators, because of the larger heat transfer area made possible through the use of multiple tubes and multiple passes of the gases.

Radiation/Convective Hybrid Recuperator:

For maximum effectiveness of heat transfer, combinations of radiation and convective designs are used, with the high-temperature radiation recuperator being first followed by convection type.

These are more expensive than simple metallic radiation recuperators, but are less bulky. A Convective/radiative Hybrid recuperator is shown in Figure 8.4

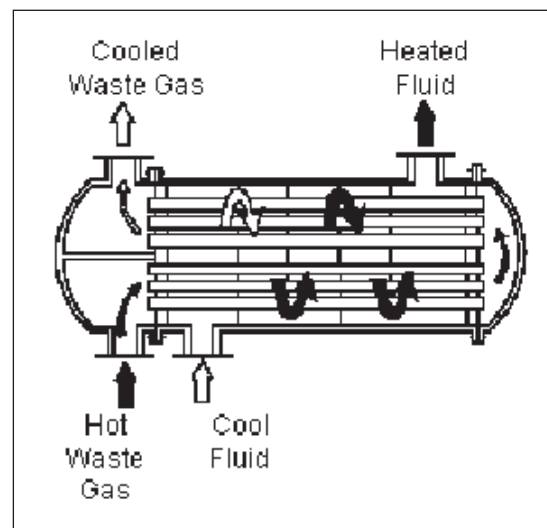

Figure 8.3 Convective Recuperator

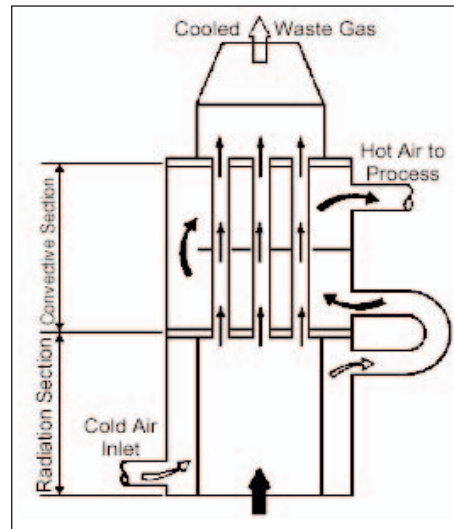

Figure 8.4 Convective Radiative Recuperator

Ceramic Recuperator

The principal limitation on the heat recovery of metal recuperators is the reduced life of the liner at inlet temperatures exceeding 1100°C . In order to overcome the temperature limitations of metal recuperators, ceramic tube recuperators have been developed whose materials allow operation on the gas side to 1550°C and on the preheated air side to 815°C on a more or less practical basis. Early ceramic recuperators were built of tile and joined with furnace cement, and thermal cycling caused cracking of joints and rapid deterioration of the tubes. Later developments introduced various kinds of short silicon carbide tubes which can be joined by flexible seals located in the air headers.

Earlier designs had experienced leakage rates from 8 to 60 percent. The new designs are reported to last two years with air preheat temperatures as high as 700°C , with much lower leakage rates.

Regenerator

The Regeneration which is preferable for large capacities has been very widely used in glass and steel melting furnaces. Important relations exist between the size of the regenerator, time between reversals, thickness of brick, conductivity of brick and heat storage ratio of the brick.

In a regenerator, the time between the reversals is an important aspect. Long periods would mean higher thermal storage and hence higher cost. Also long periods of reversal result in lower average temperature of preheat and consequently reduce fuel economy. (Refer Figure 8.5).

Accumulation of dust and slagging on the surfaces reduce efficiency of the heat transfer as the furnace becomes old.

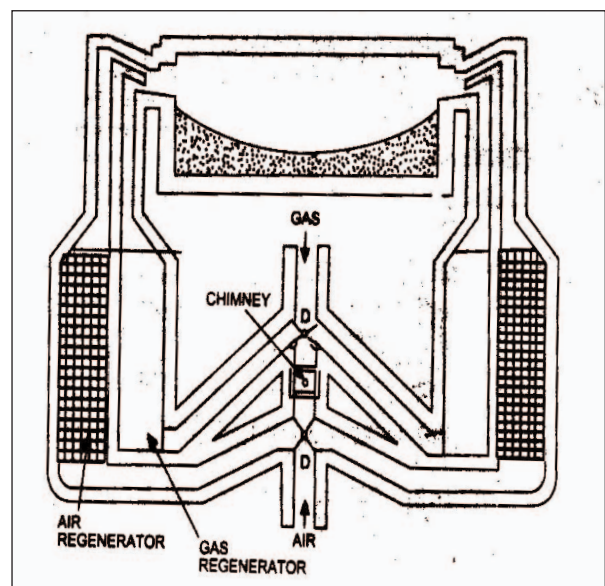

Figure 8.5 Regenerator

Heat losses from the walls of the regenerator and air in leaks during the gas period and out-leaks during air period also reduces the heat transfer.

Heat Wheels

A heat wheel is finding increasing applications in low to medium temperature waste heat recovery systems. Figure 8.6 is a sketch illustrating the application of a heat wheel.

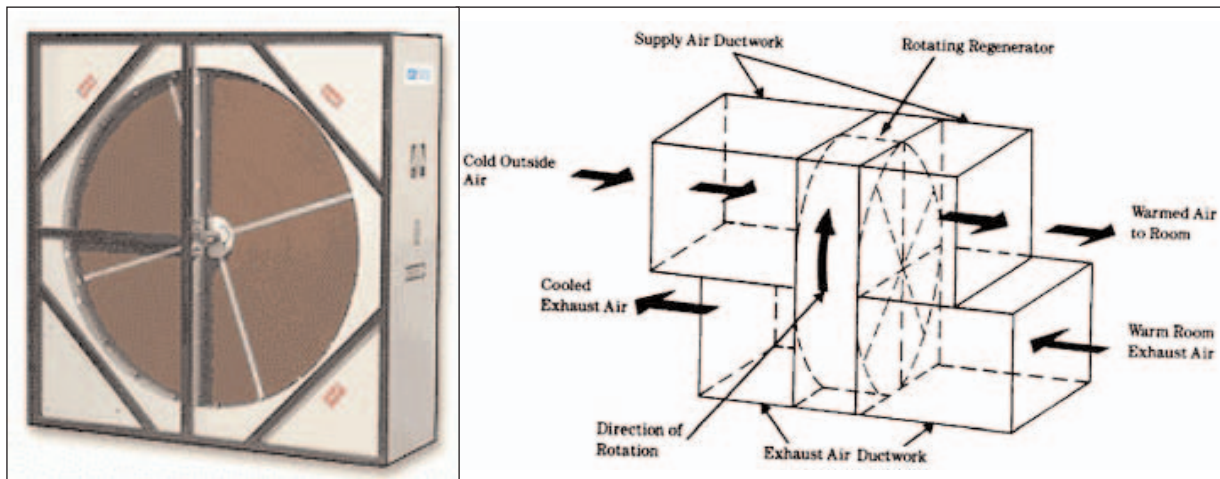

Figure 8.6 Heat Wheel

It is a sizable porous disk, fabricated with material having a fairly high heat capacity, which rotates between two side-by-side ducts: one a cold gas duct, the other a hot gas duct. The axis of the disk is located parallel to, and on the partition between, the two ducts. As the disk slowly rotates, sensible heat (moisture that contains latent heat) is transferred to the disk by the hot air and, as the disk rotates, from the disk to the cold air. The overall efficiency of sensible heat transfer for this kind of regenerator can be as high as 85 percent. Heat wheels have been built as large as 21 metres in diameter with air capacities up to $1130 \text{ m}^3 / \text{min}$.

A variation of the Heat Wheel is the rotary regenerator where the matrix is in a cylinder rotating across the waste gas and air streams. The heat or energy recovery wheel is a rotary gas heat regenerator, which can transfer heat from exhaust to incoming gases.

Its main area of application is where heat exchange between large masses of air having small temperature differences is required. Heating and ventilation systems and recovery of heat from dryer exhaust air are typical applications.

Case Example

A rotary heat regenerator was installed on a two colour printing press to recover some of the heat, which had been previously dissipated to the atmosphere, and used for drying stage of the process. The outlet exhaust temperature before heat recovery was often in excess of 100°C . After heat recovery the temperature was 35°C . Percentage heat recovery was 55% and payback on the investment was estimated to be about 18 months. Cross contamination of the fresh air from the solvent in the exhaust gases was at a very acceptable level.

Case Example

A ceramic firm installed a heat wheel on the preheating zone of a tunnel kiln where 7500 m³/hour of hot gas at 300°C was being rejected to the atmosphere. The result was that the flue gas temperature was reduced to 150°C and the fresh air drawn from the top of the kiln was preheated to 155°C. The burner previously used for providing the preheated air was no longer required. The capital cost of the equipment was recovered in less than 12 months.

Heat Pipe

A heat pipe can transfer up to 100 times more thermal energy than copper, the best known conductor. In other words, heat pipe is a thermal energy absorbing and transferring system and have no moving parts and hence require minimum maintenance.

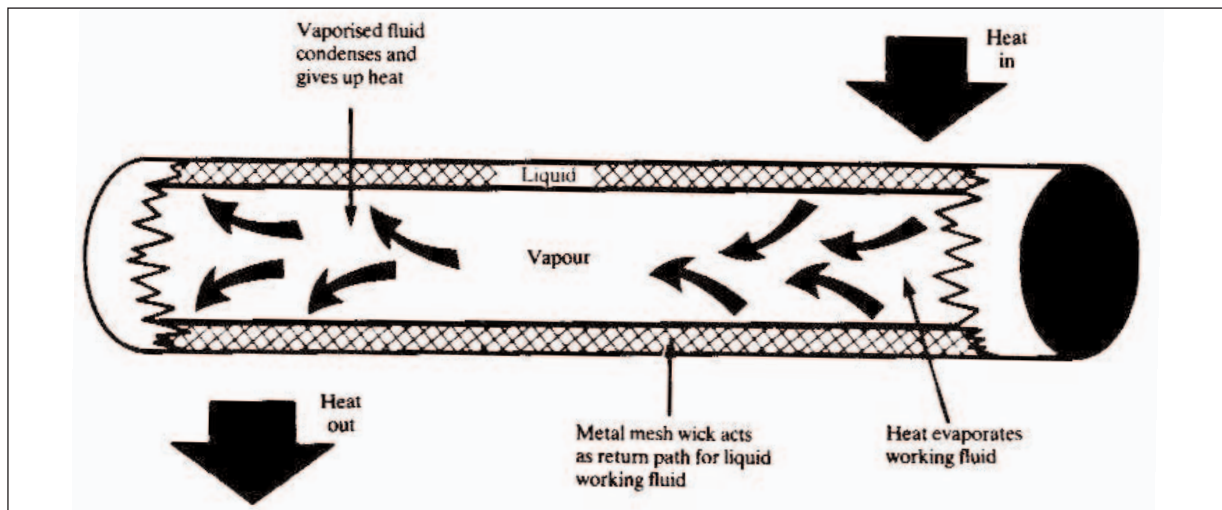

Figure 8.7 Heat Pipe

The Heat Pipe comprises of three elements - a sealed container, a capillary wick structure and a working fluid. The capillary wick structure is integrally fabricated into the interior surface of the container tube and sealed under vacuum. Thermal energy applied to the external surface of the heat pipe is in equilibrium with its own vapour as the container tube is sealed under vacuum. Thermal energy applied to the external surface of the heat pipe causes the working fluid near the surface to evaporate instantaneously. Vapour thus formed absorbs the latent heat of vapourisation and this part of the heat pipe becomes an evaporator region. The vapour then travels to the other end the pipe where the thermal energy is removed causing the vapour to condense into liquid again, thereby giving up the latent heat of the condensation. This part of the heat pipe works as the condenser region. The condensed liquid then flows back to the evaporated region. A figure of Heat pipe is shown in Figure 8.7

Performance and Advantage

The heat pipe exchanger (HPHE) is a lightweight compact heat recovery system. It virtually does not need mechanical maintenance, as there are no moving parts to wear out. It does not need input power for its operation and is free from cooling water and lubrication systems. It also lowers the fan horsepower requirement and increases the overall thermal efficiency of the system. The heat pipe heat recovery systems are capable of operating at 315°C. with 60% to 80% heat recovery capability.

Typical Application

The heat pipes are used in following industrial applications:

- a. **Process to Space Heating:** The heat pipe heat exchanger transfers the thermal energy from process exhaust for building heating. The preheated air can be blended if required. The requirement of additional heating equipment to deliver heated make up air is drastically reduced or eliminated.
- b. **Process to Process:** The heat pipe heat exchangers recover waste thermal energy from the process exhaust and transfer this energy to the incoming process air. The incoming air thus become warm and can be used for the same process/other processes and reduces process energy consumption.
- c. **HVAC Applications:**

Cooling: Heat pipe heat exchangers precool the building make up air in summer and thus reduces the total tons of refrigeration, apart from the operational saving of the cooling system. Thermal energy is supply recovered from the cool exhaust and transferred to the hot supply make up air.

Heating: The above process is reversed during winter to preheat the make up air.

The other applications in industries are:

- Preheating of boiler combustion air
- Recovery of Waste heat from furnaces
- Reheating of fresh air for hot air driers
- Recovery of waste heat from catalytic deodorizing equipment
- Reuse of Furnace waste heat as heat source for other oven
- Cooling of closed rooms with outside air
- Preheating of boiler feed water with waste heat recovery from flue gases in the heat pipe economizers.
- Drying, curing and baking ovens
- Waste steam reclamation
- Brick kilns (secondary recovery)
- Reverberatory furnaces (secondary recovery)
- Heating, ventilating and air-conditioning systems

Case Example

Savings in Hospital Cooling Systems

Volume	140 m ³ /min Exhaust
Recovered heat	28225 kCal/hr
Plant capacity reduction	9.33 Tons of Refrigeration
Electricity cost (operation)	Rs. 268/Million kCal (based on 0.8 kW/TR)
Plant capacity reduction cost (Capital)	Rs.12,000/TR
Capital cost savings	Rs. 1,12,000/-
Payback period	16570 hours

Economiser

In case of boiler system, economizer can be provided to utilize the flue gas heat for pre-heating the boiler feed water. On the other hand, in an air pre-heater, the waste heat is used to heat combustion air. In both the cases, there is a corresponding reduction in the fuel requirements of the boiler. An economizer is shown in Figure 8.8.

For every 22°C reduction in flue gas temperature by passing through an economiser or a pre-heater, there is 1% saving of fuel in the boiler. In other words, for every 6°C rise in feed water temperature through an economiser, or 20°C rise in combustion air temperature through an air pre-heater, there is 1% saving of fuel in the boiler.

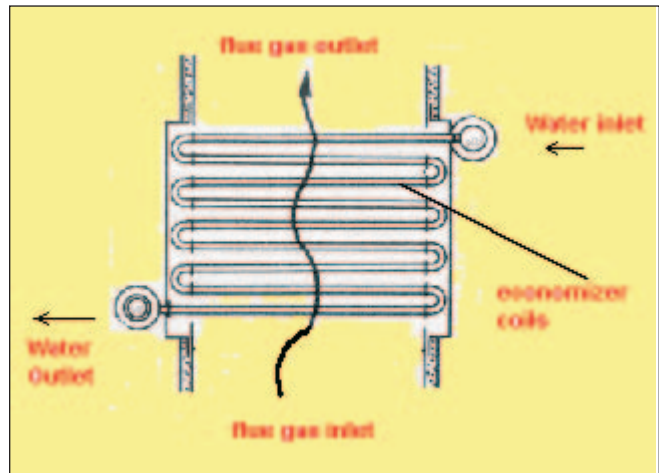

Figure 8.8 Economiser

Shell and Tube Heat Exchanger:

When the medium containing waste heat is a liquid or a vapor which heats another liquid, then the shell and tube heat exchanger must be used since both paths must be sealed to contain the pressures of their respective fluids. The shell contains the tube bundle, and usually internal baffles, to direct the fluid in the shell over the tubes in multiple passes. The shell is inherently weaker than the tubes so that the higher-pressure fluid is circulated in the tubes while the lower pressure fluid flows through the shell. When a vapor contains the waste heat, it usually condenses, giving up its latent heat to the liquid being heated. In this application, the vapor is almost invariably contained within the shell. If the reverse is attempted, the condensation of vapors within small diameter parallel tubes causes flow instabilities. Tube and shell heat exchangers are available in a wide range of standard sizes with many combinations of materials for the tubes and shells. A shell and tube heat exchanger is illustrated in Figure 8.9.

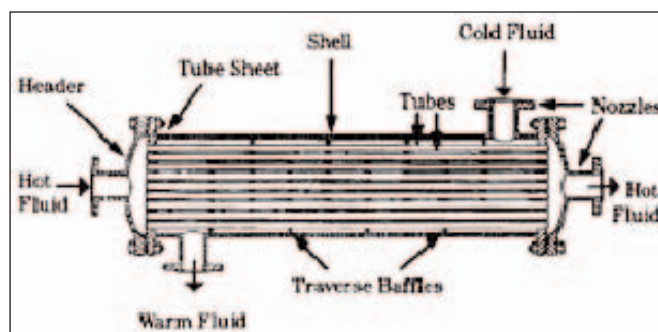

Figure 8.9 Shell & Tube Heat Exchanger

Typical applications of shell and tube heat exchangers include heating liquids with the heat contained by condensates from refrigeration and air-conditioning systems; condensate from process steam; coolants from furnace doors, grates, and pipe supports; coolants from engines, air compressors, bearings, and lubricants; and the condensates from distillation processes.

Plate heat exchanger

The cost of heat exchange surfaces is a major cost factor when the temperature differences are not large. One way of meeting this problem is the plate type heat exchanger, which consists of a series of separate parallel plates forming thin flow pass. Each plate is separated from the next by gaskets and the hot stream passes in parallel through alternative plates whilst the liquid to be heated passes in parallel between the hot plates. To improve heat transfer the plates are corrugated.

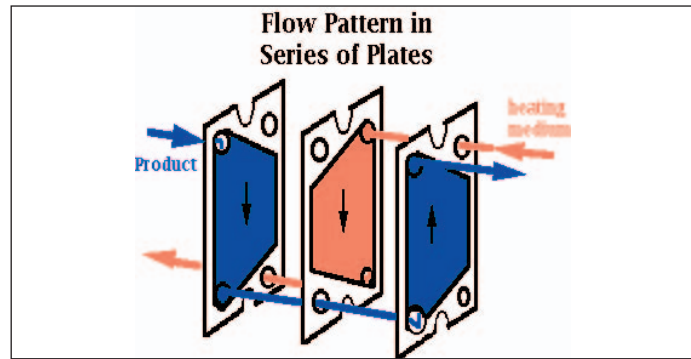

Figure 8.10 Plate Heat Exchanger

Hot liquid passing through a bottom port in the head is permitted to pass upwards between every second plate while cold liquid at the top of the head is permitted to pass downwards between the odd plates. When the directions of hot & cold fluids are opposite, the arrangement is described as counter current. A plate heat exchanger is shown in Figure 8.10.

Typical industrial applications are:

- Pasteurisation section in milk packaging plant.
- Evaporation plants in food industry.

Run Around Coil Exchanger

It is quite similar in principle to the heat pipe exchanger. The heat from hot fluid is transferred to the colder fluid via an intermediate fluid known as the Heat Transfer Fluid. One coil of this closed loop is installed in the hot stream while the other is in the cold stream. Circulation of this fluid is maintained by means of circulating pump.

It is more useful when the hot and cold fluids are located far away from each other and are not easily accessible.

Typical industrial applications are heat recovery from ventilation, air conditioning and low temperature heat recovery.

Waste Heat Boilers

Waste heat boilers are ordinarily water tube boilers in which the hot exhaust gases from gas turbines, incinerators, etc., pass over a number of parallel tubes containing water. The water is vaporized in the tubes and collected in a steam drum from which it is drawn off for use as heating or processing steam.

Because the exhaust gases are usually in the medium temperature range and in order to conserve space, a more compact boiler can be produced if the water tubes are finned in order to increase the effective heat transfer area on the gas side. The Figure 8.11 shows a mud drum, a set of tubes over which the hot gases make a double pass, and a steam drum which collects the steam generated above the water surface. The pressure at which the steam is generated and the rate of steam production depends on the temperature of waste heat. The pressure of a pure vapor in the presence of its liquid is a function of the temperature of the liquid from which it is evaporated. The steam tables tabulate this relationship between saturation pressure and temperature.

If the waste heat in the exhaust gases is insufficient for generating the required amount of process steam, auxiliary burners which burn fuel in the waste heat boiler or an after-burner in the exhaust gases flue are added. Waste heat boilers are built in capacities from 25 m³ almost 30,000 m³ / min. of exhaust gas.

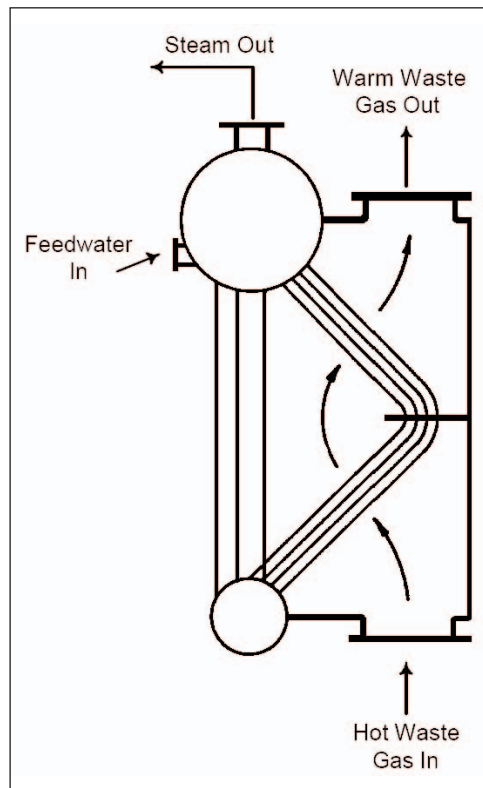

Figure 8.11 Two-Pass Water Tube Waste Heat Recovery Boiler

Typical applications of waste heat boilers are to recover energy from the exhausts of gas turbines, reciprocating engines, incinerators, and furnaces.

Case Example

Gases leaving a carbon black plant rich in carbon monoxide which are vented to the atmosphere.

Equipment Suggested	Carbon monoxide incinerator along with waste heat boiler and steam turbine
Estimated equipment cost	Rs.350 Lakhs
New boiler efficiency	80%
Savings by way of power generated	~Rs.160 Lakhs /annum
Indirect benefits	Reduction in pollution levels

Heat Pumps:

In the various commercial options previously discussed, we find waste heat being transferred from a hot fluid to a fluid at a lower temperature. Heat must flow spontaneously "downhill",

that is from a system at high temperature to one at a lower temperature. When energy is repeatedly transferred or transformed, it becomes less and less available for use. Eventually that energy has such low intensity (resides in a medium at such low temperature) that it is no longer available at all to perform a useful function. It has been taken as a general rule of thumb in industrial operations that fluids with temperatures less than 120°C (or, better, 150°C to provide a safe margin), as limit for waste heat recovery because of the risk of condensation of corrosive liquids. However, as fuel costs continue to rise, even such waste heat can be used economically for space heating and other low temperature applications. It is possible to reverse the direction of spontaneous energy flow by the use of a thermodynamic system known as a heat pump.

The majority of heat pumps work on the principle of the vapour compression cycle. In this cycle, the circulating substance is physically separated from the source (waste heat, with a temperature of T_{in}) and user (heat to be used in the process, T_{out}) streams, and is re-used in a cyclical fashion, therefore called 'closed cycle'. In the heat pump, the following processes take place:

1. In the evaporator the heat is extracted from the heat source to boil the circulating substance;
2. The circulating substance is compressed by the compressor, raising its pressure and temperature; The low temperature vapor is compressed by a compressor, which requires external work. The work done on the vapor raises its pressure and temperature to a level where its energy becomes available for use
3. The heat is delivered to the condenser;
4. The pressure of the circulating substance (working fluid) is reduced back to the evaporator condition in the throttling valve, where the cycle repeats.

The heat pump was developed as a space heating system where low temperature energy from the ambient air, water, or earth is raised to heating system temperatures by doing compression work with an electric motor-driven compressor. The arrangement of a heat pump is shown in figure 8.12.

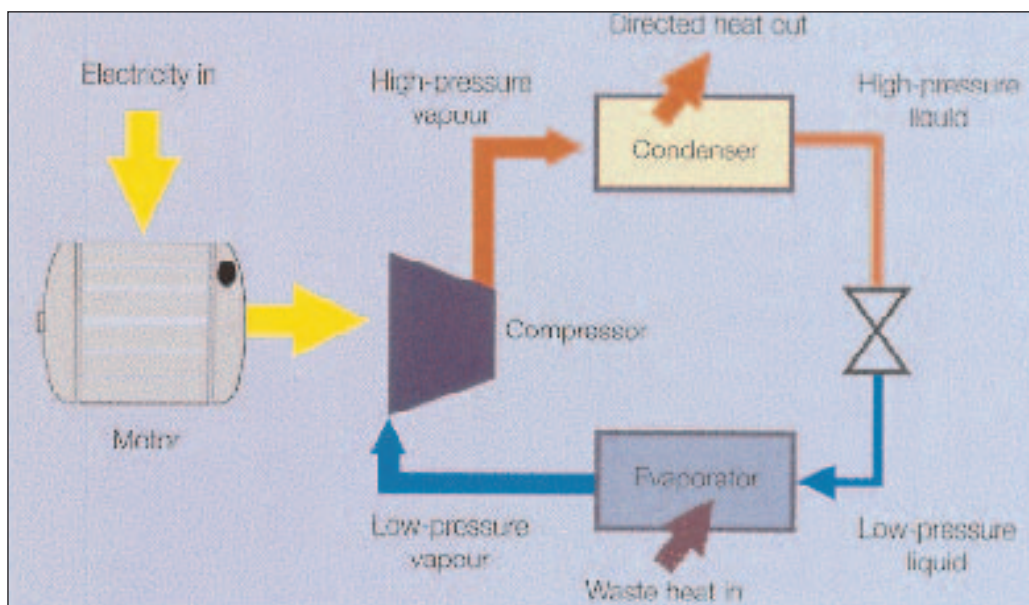

Figure 8.12 Heat Pump Arrangement

The heat pumps have the ability to upgrade heat to a value more than twice that of the energy consumed by the device. The potential for application of heat pump is growing and number of industries have been benefited by recovering low grade waste heat by upgrading it and using it in the main process stream.

Heat pump applications are most promising when both the heating and cooling capabilities can be used in combination. One such example of this is a plastics factory where chilled water from a heat is used to cool injection-moulding machines whilst the heat output from the heat pump is used to provide factory or office heating. Other examples of heat pump installation include product drying, maintaining dry atmosphere for storage and drying compressed air.

Thermocompressor :

In many cases, very low pressure steam are reused as water after condensation for lack of any better option of reuse. In many cases it becomes feasible to compress this low pressure steam by very high pressure steam and reuse it as a medium pressure steam. The major energy in steam, is in its latent heat value and thus thermocompressing would give a large improvement in waste heat recovery.

The thermocompressor is a simple equipment with a nozzle where HP steam is accelerated into a high velocity fluid. This entrains the LP steam by momentum transfer and then recompresses in a divergent venturi. A figure of thermocompressor is shown in Figure 8.13.

It is typically used in evaporators where the boiling steam is recompressed and used as heating steam.

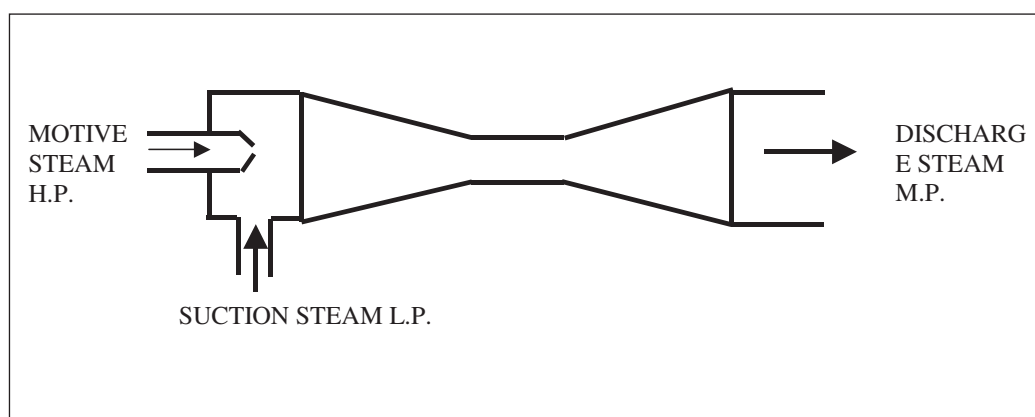

Figure 8.13 Thermocompressor

Case Example

Exhaust steam from evaporator in a fruit juice concentrator plant was condensed in a precondenser operation on cooling water upstream of a steam jet vacuum ejector

Equipment Suggested	Alt-1 Thermocompressor Alt-2 shell & tube exchanger
Cost of thermocompressor	Rs.1.5 Lakhs
Savings of jacket steam due to recompression of vapour	Rs.5.0 Lakhs per annum
Cost of shell & tube exchanger to preheat boiler feed water	Rs.75,000/-
Savings in fuel cost	~Rs.4.5 Lakhs per annum

Direct Contact Heat Exchanger :

Low pressure steam may also be used to preheat the feed water or some other fluid where miscibility is acceptable. This principle is used in Direct Contact Heat Exchanger and finds wide use in a steam generating station. They essentially consists of a number of trays mounted one over the other or packed beds. Steam is supplied below the packing while the cold water is sprayed at the top. The steam is completely condensed in the incoming water thereby heating it. A figure of direct contact heat exchanger is shown in Figure 8.14. Typical application is in the deaerator of a steam generation station.

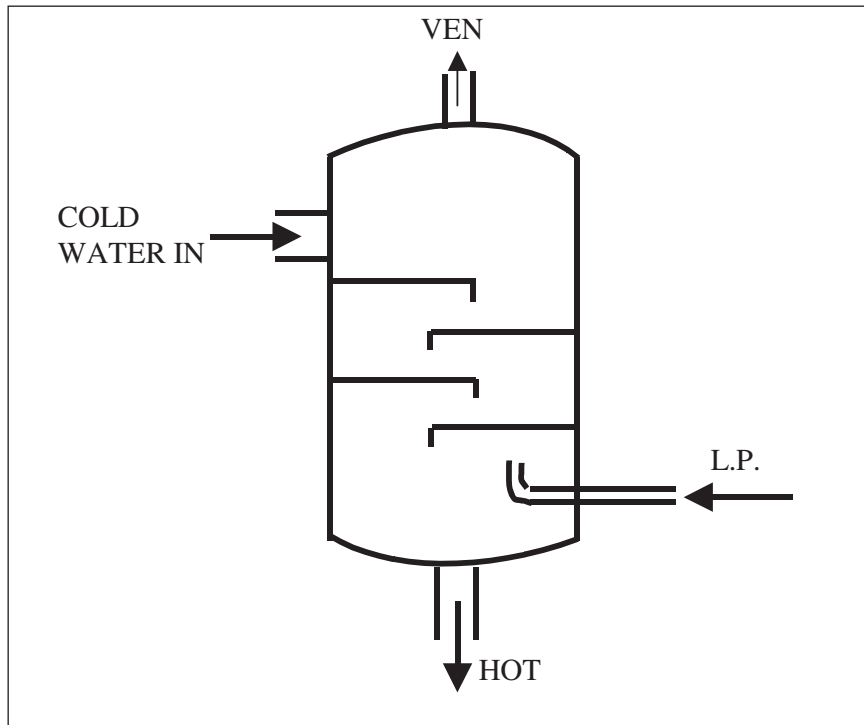

Figure 8.14 Direct Contact Condenser

QUESTIONS

1.	What do you understand by the term waste heat?
2.	The heat recovery equipment will be the cheapest when the temperature of flue gases are (a) 200°C (b) 400°C (c) 600°C (d) 800°C
3.	Give two examples of waste heat recovery.
4.	What are the direct and indirect benefits of waste heat recovery?
5.	How will you go about developing a waste heat recovery system?
6.	Explain the various types of recuperators.
7.	The ceramic recuperators can withstand temperatures upto (a) 400°C (b) 1700°C (c) 1300°C (d) 1400°C
8.	Explain the operating principle of a regenerator.
9.	What are heat wheels? Explain with sketch.
10.	Explain the principle of operation of a heat pipe.
11.	What are the typical applications of a heat pipe in heat exchangers ?
12.	Explain the operation of an economizer.
13.	How does a shell and tube heat exchanger work? Give typical examples.
14.	How does a plate heat exchanger work? Give typical examples.
15.	Explain the operating principle of a run around coil exchanger
16.	Explain the operating principle of a waste heat recovery boiler with examples.
17.	Explain the operating principle of a heat pump with examples.

REFERENCES

1. Fuel Economy in furnaces and Waste heat recovery-PCRA
2. Heat Recovery Systems by *D.A.Reay*, E & F.N.Span, London, 1979.

www.bhes.com/frbbohome.htm

www.portalenergy.com

www.pcra.org

www.seav.vic.gov.au/ftp/advice/business/info_sheets/HeatRecoveryInfo_0_a.pdf