

Unit IV

- Special methods of heat treatment
 - Austempering
 - Martempering
 - Ausforming
 - Patenting
 - Sub-zero treatment, etc.
 - Thermo -Mechanical treatments.
- Heat treatment of
 - carbon steels
 - alloy steels
 - tools
 - dies steels
 - Stainless steels (with reference to carbide precipitation and sigma phase formation) and
 - cast irons – specific examples,

- Heat treatment of non ferrous materials
 - Aluminum alloys,
 - titanium alloys and
 - copper alloys, Concept of age-hardening.
- Design for heat treatment,
 - Heat treatment furnaces
 - their temperature control
 - atmosphere control
- Defects in heat treated parts
 - Causes for the defects in heat-treated parts and remedies.

Sub Zero Treatment

- Sub-zero treatment is one of the methods to eliminate retained austenite.
- Subzero treatment consists in cooling the hardened steel to a temperature below 0°C.
- The temperature of the sub zero treatment depends on the position of M_f temperature of the steel.
- Sub-zero treatment is more effective, if it is carried out immediately after quenching operation. Usually -30 to -150°C temperature are maintained.

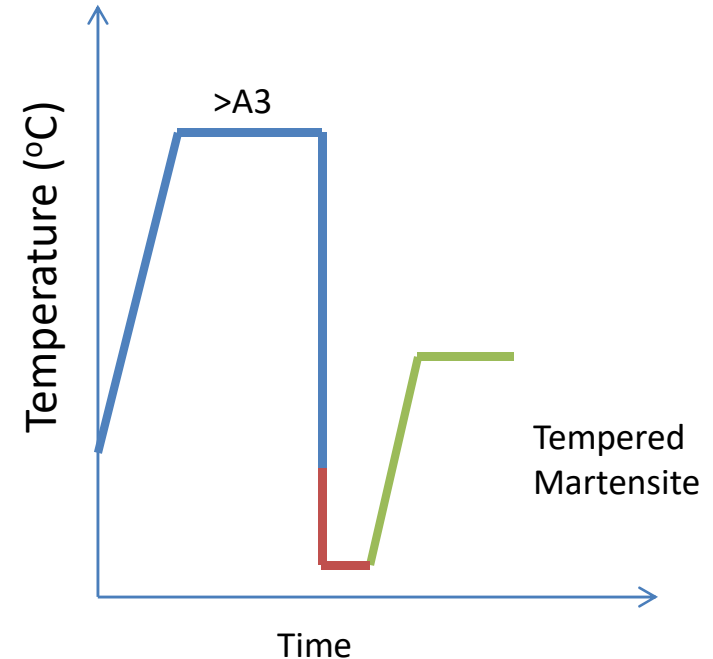

Due to the development of huge internal stress, after subzero treatment it undergoes immediately tempering. During tempering, RA transformed to tempered martensite

Table : Subzero Coolants with Temperature of Application

Coolant	Minimum temperature °C
Dry ice (solid CO_2) + Acetone	-78
Ice + Salt (NaCl)	-23
Ice + Salt (CaCl_2)	-55
Liquid air	-183
Liquid Nitrogen	-196
Liquid Pentane	-129
Freon	-111

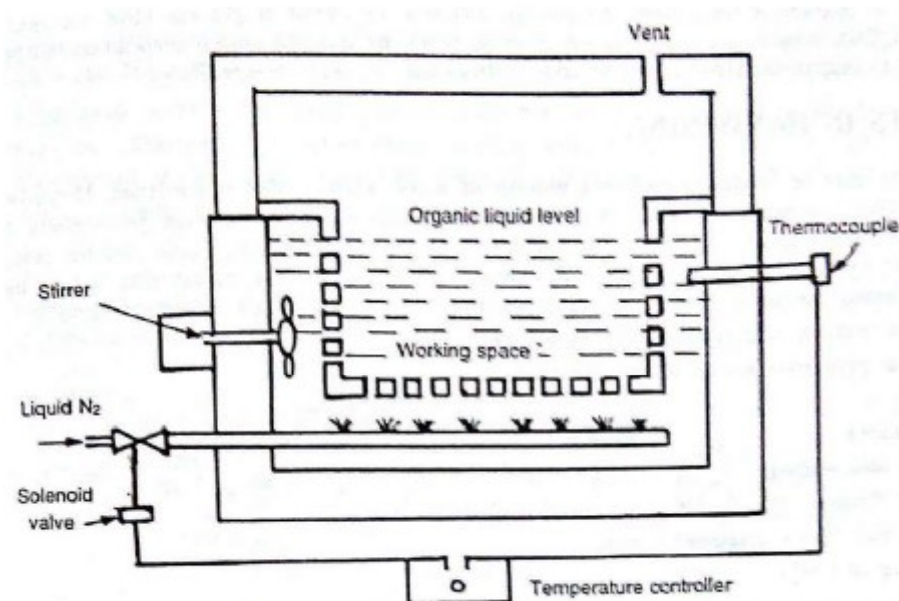
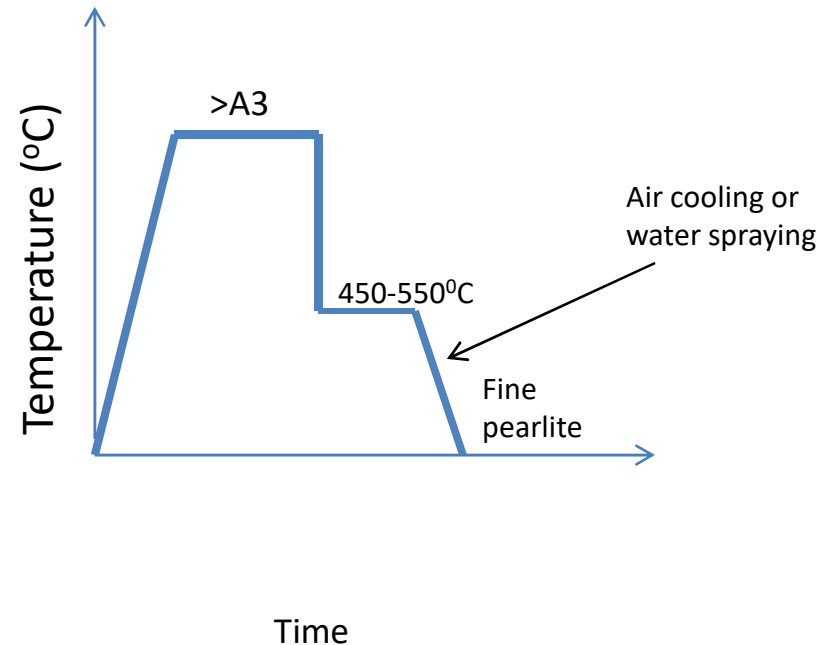

Figure : Liquid cooled (liquid N_2) system. Components are immersed in a bath of alcohol, or trichloro ethylene, which is cooled by a submerged liquid nitrogen spray (-150°C), cooling rates can be controlled.

Patenting

- Heat treatment for medium, high carbon and low alloy steel wire rod undergoes this treatment
- Quenching medium : lead bath or salt bath
- Temperature: near nose of TTT curve
- Phase formed: fine pearlite (some cases upper bainite)



Thermo-Mechanical Treatment (TMT)

- Thermo – **Heat** and Mechanical – **pressure or load**
- Simultaneous application of various combination of heat treatments and deformation process is called as TMT. During this process materials undergoes simultaneous reduction and phase transformation.
- Classification: Based on temperature of deformation of austenite
 - High temperature Thermo-Mechanical Treatment (HTMT)
 - Low temperature Thermo-Mechanical Treatment (LTMT)(or)
 - Super critical TMT
 - Inter critical TMT
 - Subcritical TMT

HTMT Vs. LTMT

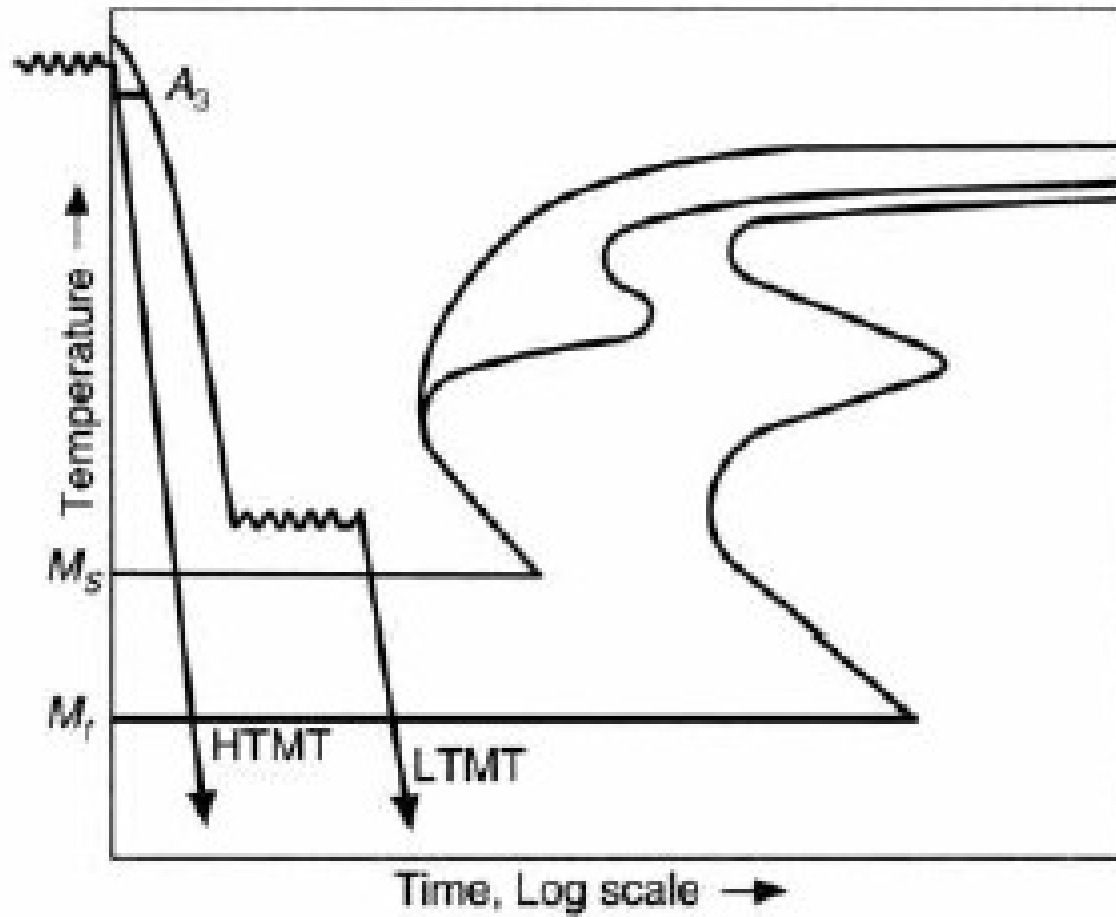

HTMT

- Deformation of austenite above recrystallization temperature followed by quenching
- Obtained strength is higher than conventional hardening but lower than LTMT
- Similar to hot working, recrystallization eliminates strain hardening effect
- Percentage of reduction 20-30%
- Better ductility and impact strength

LTMT

- Austenite is supercooled below recrystallization temperature, the supercooled austenite is deformed at this temperature followed by rapid cooling.
- Obtained strength is higher than HTMT
- Similar to transformation of cold worked austenite
- Percentage of reduction 80-90%
- Ductility is comparatively low.

Classification of TMT: Based on the critical temperature

Class	Temperature Range (for deformation)	Examples
Supercritical TMT or high	Above upper critical temp. (May or may not recrystallization take place)	Hot-cold working, controlled rolling
Intercritical TMT	$A_3 < T < A_1$ (Dual phase ferrite and martensite phase is present)	
Subcritical TMT or Low temperature TMT	$< A_1$	Isoforming, Ausforming

Hot-Cold Working -HTMT

- May or may not recrystallization takes place. It is based on the alloying element present.
- The non-recrystallized austenite is transformed into martensite by rapid quenching.
- In this process, work is carried out at minimum possible temperature above the austenitizing temperature.
- In order to control recrystallization, alloying elements such as V, Ti or Nb are added to steel.
- The steels have strong directional properties.
- Mechanical properties, such as strength, ductility, impact and fatigue strength are considerably improved by this process.

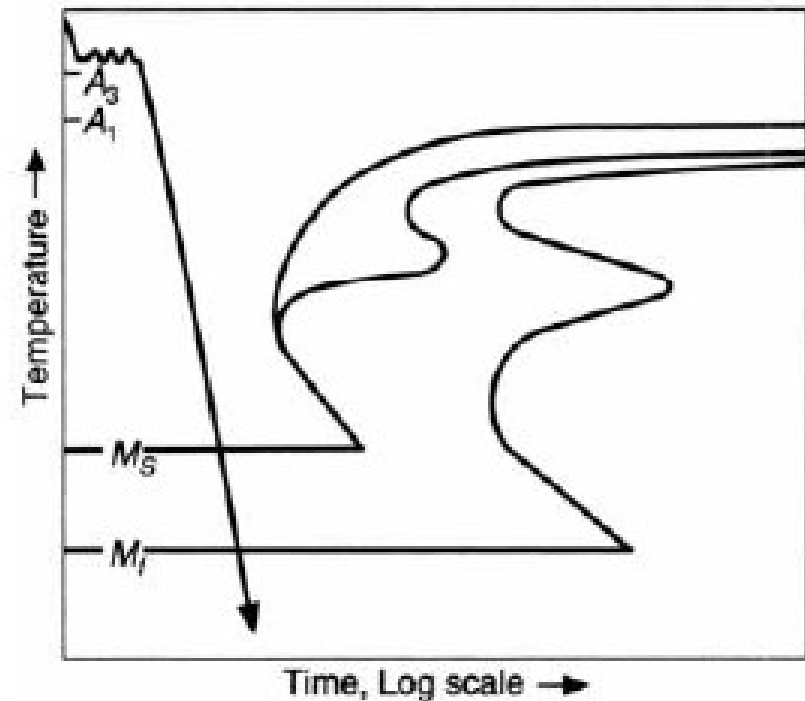

Controlled Rolling

- Very high strength levels are obtained by controlled rolling.
- Applicable for **high strength low alloy (HSLA) steel**. (High strength due to fine ferrite, pearlite and carbides)
- This process consists of heating steel $> A_3$ i.e., stable γ temp. range. Austenite is deformed, and conditions are maintained to obtain fine grains of recrystallized austenite.
- The grain growth maintained by the hot working process variables and presence of second phase particles.
- Second phase particles: carbides of microalloying elements such as Nb, V & Ti
- Carbides of microalloying elements \rightarrow control the growth of austenitic grains and retard the rate of recrystallization. However, the carbide of microalloying elements are effective only up to about 1050°C , and so rolling should be performed below this temperature.
- Fine austenitic grains will result in fine ferritic grains in the final structure. Ferritic grains nucleate at austenitic grain boundaries. Finer the austenitic grains \rightarrow finer ferritic grains. Important to check grain growth during Recrystallization.
- In order to have max. strengthening, heavy deformation and low finishing temp. should be chosen. The process is widely employed for HSLA steels.

Ausforming - LTMT

- No transformation during deformation.
- Applicable for steel having gap between pearlite and bainitic C curve
- Independent of C amount. (Min. 0.05 to 0.10% of C)
- Carbide forming elements increases the strength.
- Alloying element which raise stacking fault energy of austenite reduces the strength. Ex.: Ni
- Extent of strengthening due to amount, temperature (450 to 650°C) and deformation.
- Ausforming steel have improved strength and ductility compared to conventional hardened and tempered steel.

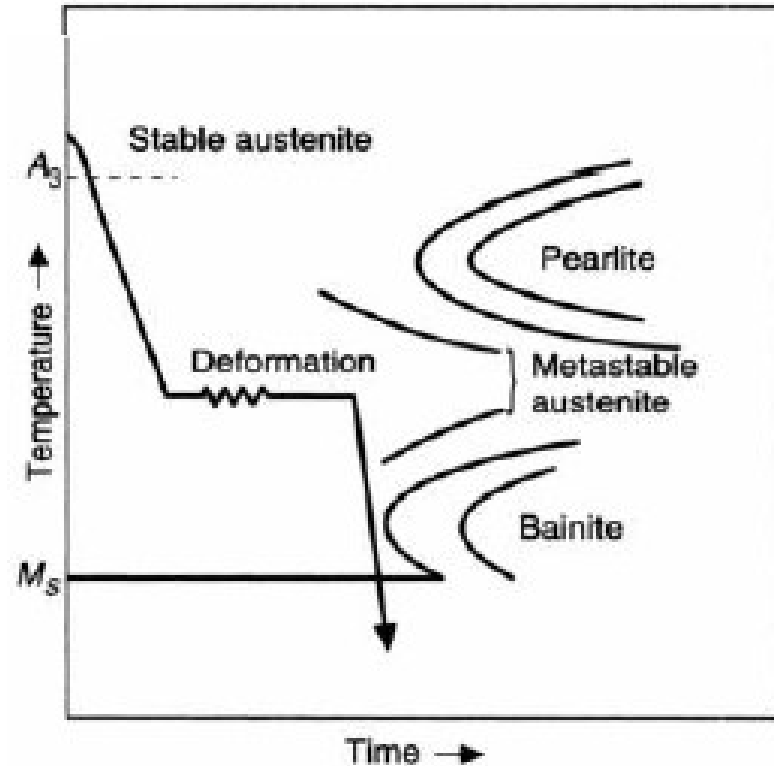

Isoforming

- The isoforming process consists of *deforming steel below the lower critical temperature during transformation.*
- Resultant phase: fine pearlite or bainite, depending on the conditions.
- The process is called isoforming because transformation proceeds isothermally.
- Sufficient time should be available at this temperature for carrying out the deformation process and for the metastable austenite to transform isothermally to pearlite.
- Just after the completion of the transformation, steel is quenched.
- The larger the deformation or lower the deformation temperature, the greater is the level of strength developed in the steel.
- Bainitic structure can be achieved in the final product in the same way

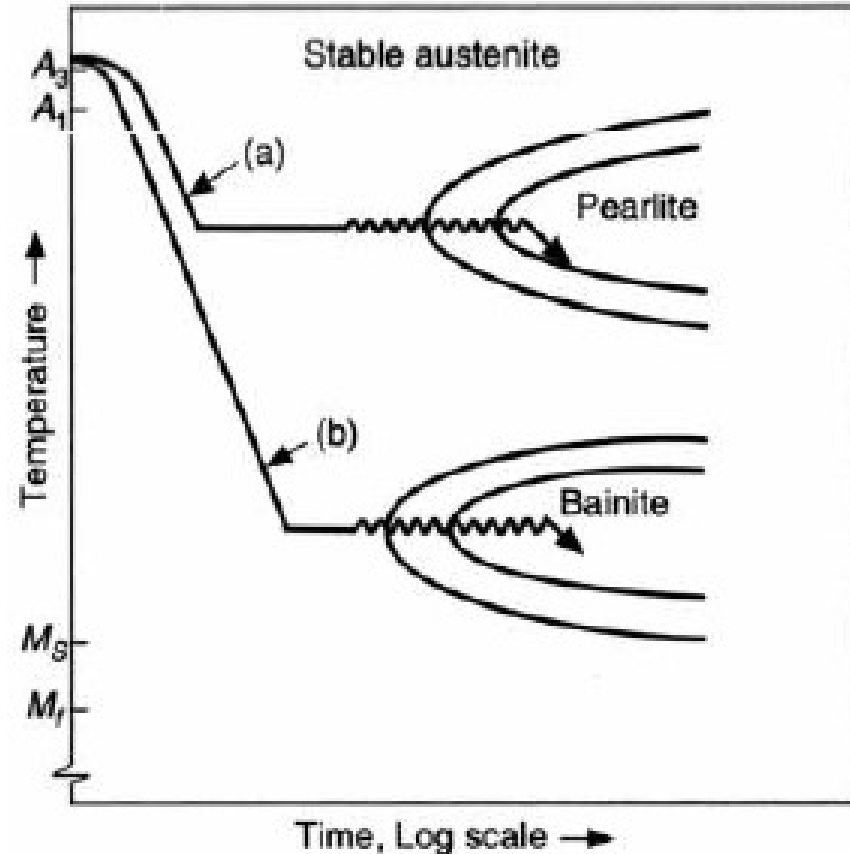

Marstraining

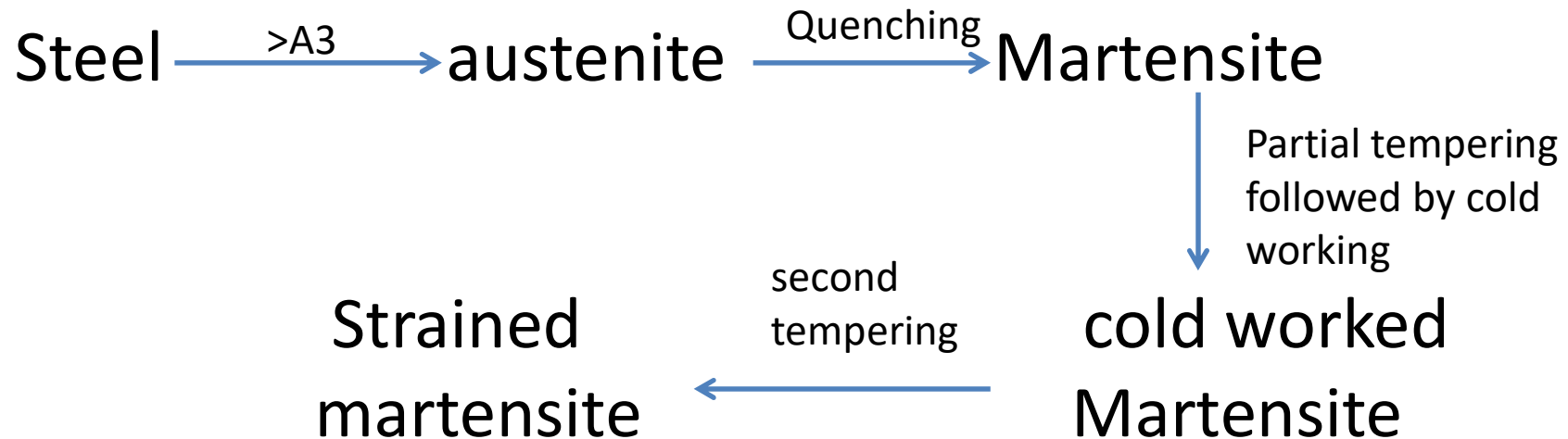

- The second tempering temperature should be lower than the first one.
- The process produces strain ageing and results in significant improvement in yield strength and tensile strength levels.
- It is believed that epsilon carbide formed at low tempering temperature dissolves during deformation.
- The dislocation-carbon interaction thus obtained hinders the movement of dislocations on re-tempering, and mechanical strength of the steel is improved.

Cryofforming or Zerolling

- Quenching temp.: subzero temperature
- The transformation of a part of austenite → martensite takes place during deformation
- martensite thus produced has better yield strength, tensile strength and hardness.
- When austenite gets transformed into martensite at sub-zero temperature, a noise similar to crying is produced. This crying like sound is produced because both deformation and transformation proceed simultaneously.
- The process is well suited to steels which cannot be strengthened by cold working

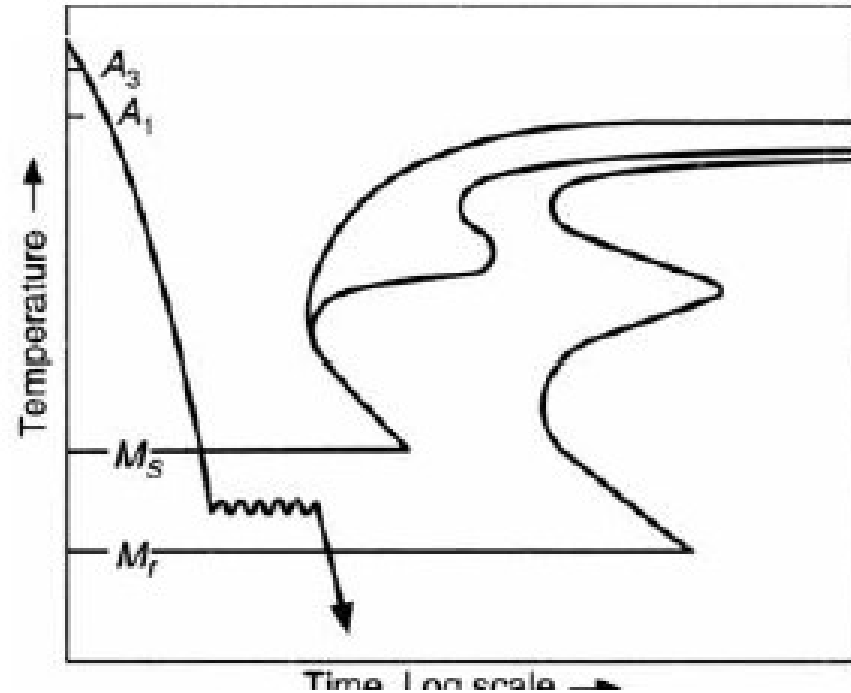

Limitation: stabilized austenite transforms to hard and brittle martensite during service at room temperature.

Preliminary Thermomechanical Treatment

- The treatment does not result in complete elimination of strain-hardening effect developed by deformation given prior to austenitizing.
- The magnitude of residual strain hardening effect depends on
 - the chemical composition of steel,
 - amount of deformation,
 - rate of deformation,
 - rate of heating to austenitizing temperature,
 - austenitizing temperature.

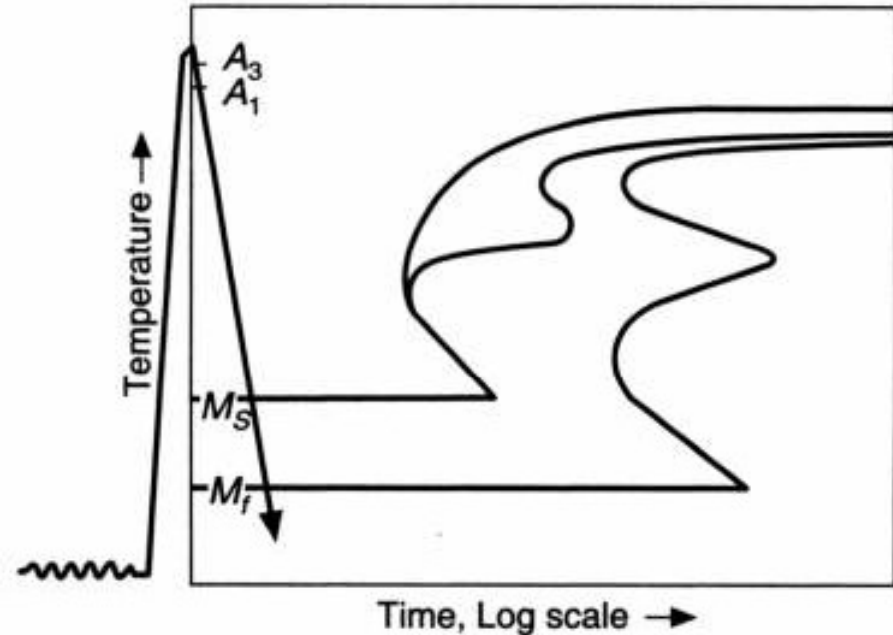

Thermo mechanical Annealing

- Temperature: $<A_3$
- Deformation: Metastable austenite deformed as it cools down.
- Deformation temp.: Minimum A_1
- Resultant phase spheroidized carbide in ferrite matrix
- Property achieved: Machinability of the alloy
- Advantage:
 - compared to spheroidizing process, this process in short time.
 - Presence of alloying element reduces the A_1 temp in spheroidizing process which result low temperature. Spheroidizing cycle and low diffusion rate an low spheroidization speeds in conventional method.

Thermomechanical Treatment of Non-Ferrous Alloys

- Applied only to age-hardenable alloys. The process consists of plastic deformation of alloys followed by aging treatment.
- Successfully studied Al, Cu, and Ni base precipitation hardenable alloys.
- Depending on the temperature of deformation, the process can be divided into two classes, namely
 - Low temperature thermomechanical treatment (LTMT)
 - High temperature thermo mechanical treatment (HTMT)

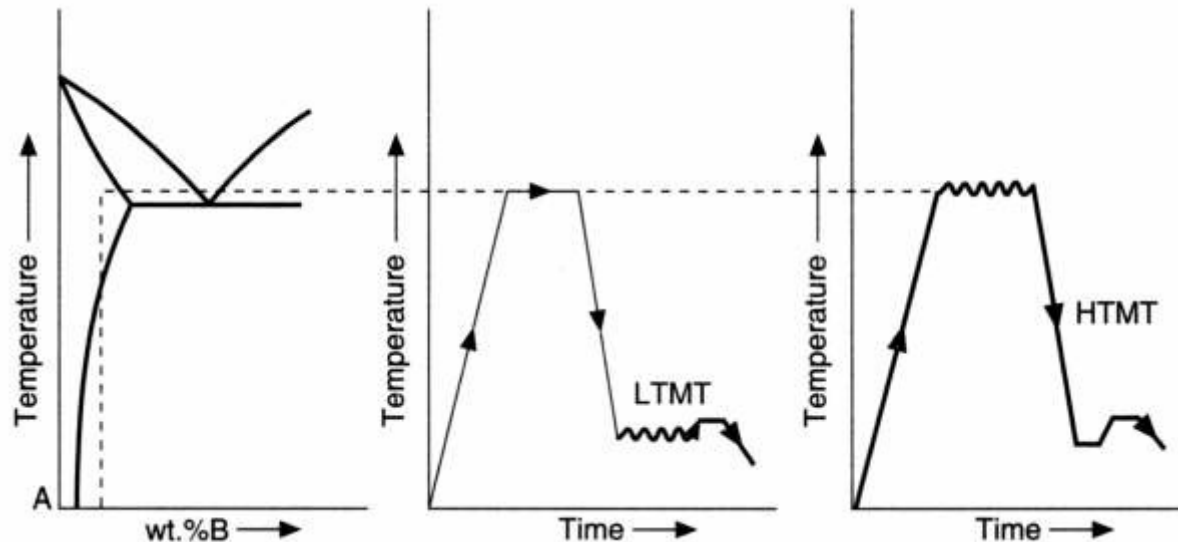

LTMT – Non Ferrous system

- Treatment results in better yield strength and tensile strength than simple age hardening treatment. However, ductility will be comparatively poor.
- The strengthening mechanism - strain hardening and interaction between crystal defects and precipitated particles.
- Highly unstable alloy undergoes acceleration during aging. Mainly due to more number of sites for nucleation second phase and increased diffusion rate

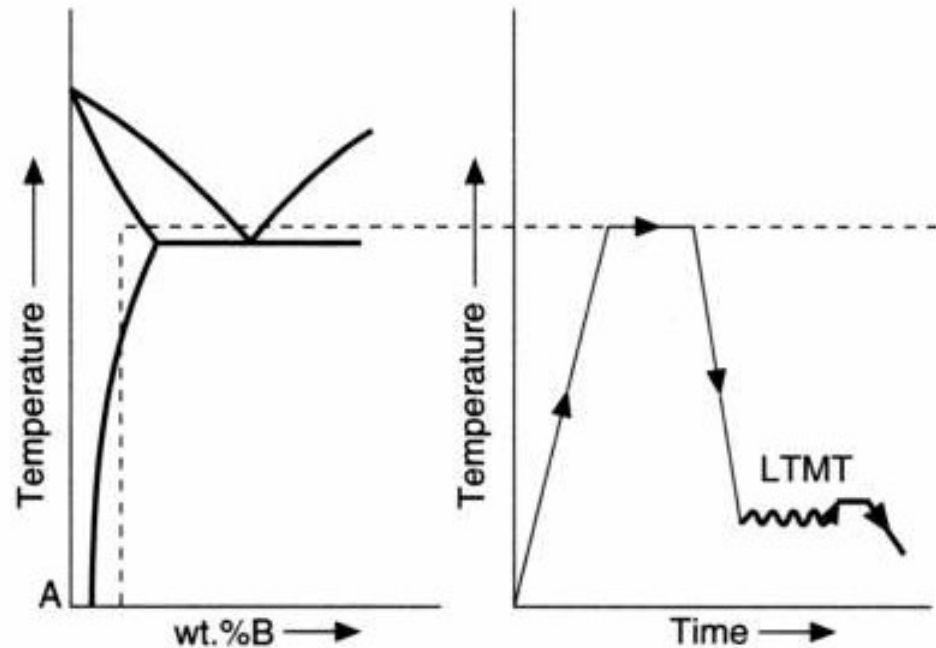

HTMT Non Ferrous System

- The HTMT consists of hot deforming solid solution (single phase) in such a way that either non-recrystallized or very feebly recrystallized structure is attained in the hot deformed alloy.
- When non-recrystallized structure is quenched, it will produce a structure with high dislocation density and crystal defects.
- After ageing yield strength improved properties are obtained by HTMT under a set of optimum conditions. These conditions are as follows.
 - The structure of hot deformed supersaturated solid solution should be nonrecrystallized. Dynamic recrystallization during hot deformation should be prevented effectively.
 - The degree of supersaturation should be sufficient to produce reasonable amount of precipitation which raises the hardening effect.
 - Optimum combination of strength and ductility is obtained by this treatment due formation of more uniform precipitation from the supersaturated solid solution and very fine grain size.

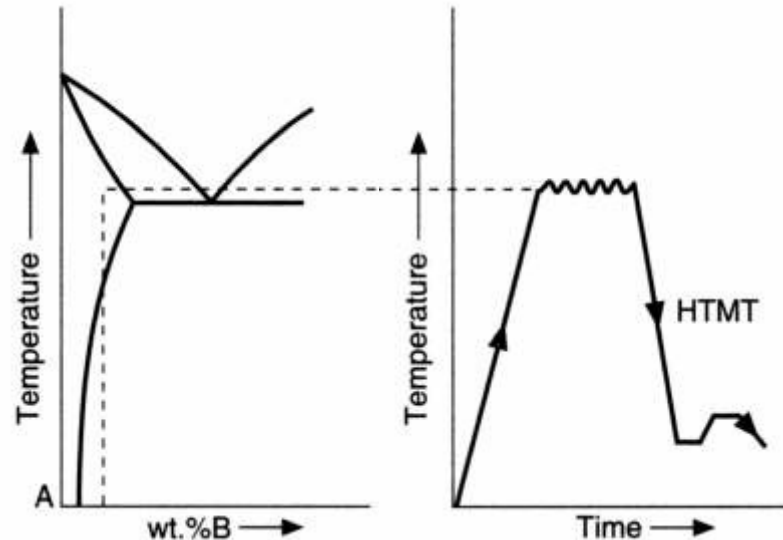

HTMT Non Ferrous System

- Hot deformation results in increased dislocation density and strain hardening . The extent of strain hardening will be less than in LTMT because of dynamic recrystallization and dynamic polygonization
- The desired structure depends on
 - temperature,
 - Rate of deformation and
 - degree of deformation.

The structure may be either strain hardened, recrystallized and polygonized, or mixed.

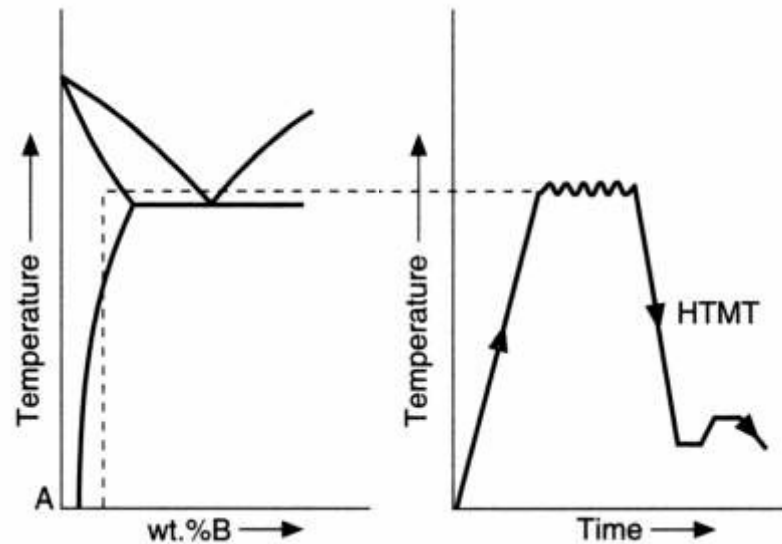

Heat treatment furnaces

All the heat treatment furnaces contains basically consists of following parts.

- Refractory vessel which contains charge and retains heat
- Heat source
- Atmosphere control
- Temperature measurement and controller device

Based on size and design, heat treatment components, heat circulation arrangement, atmosphere, introduction and removal of charge and other auxiliary of the furnaces are decided.

Classification of Furnaces

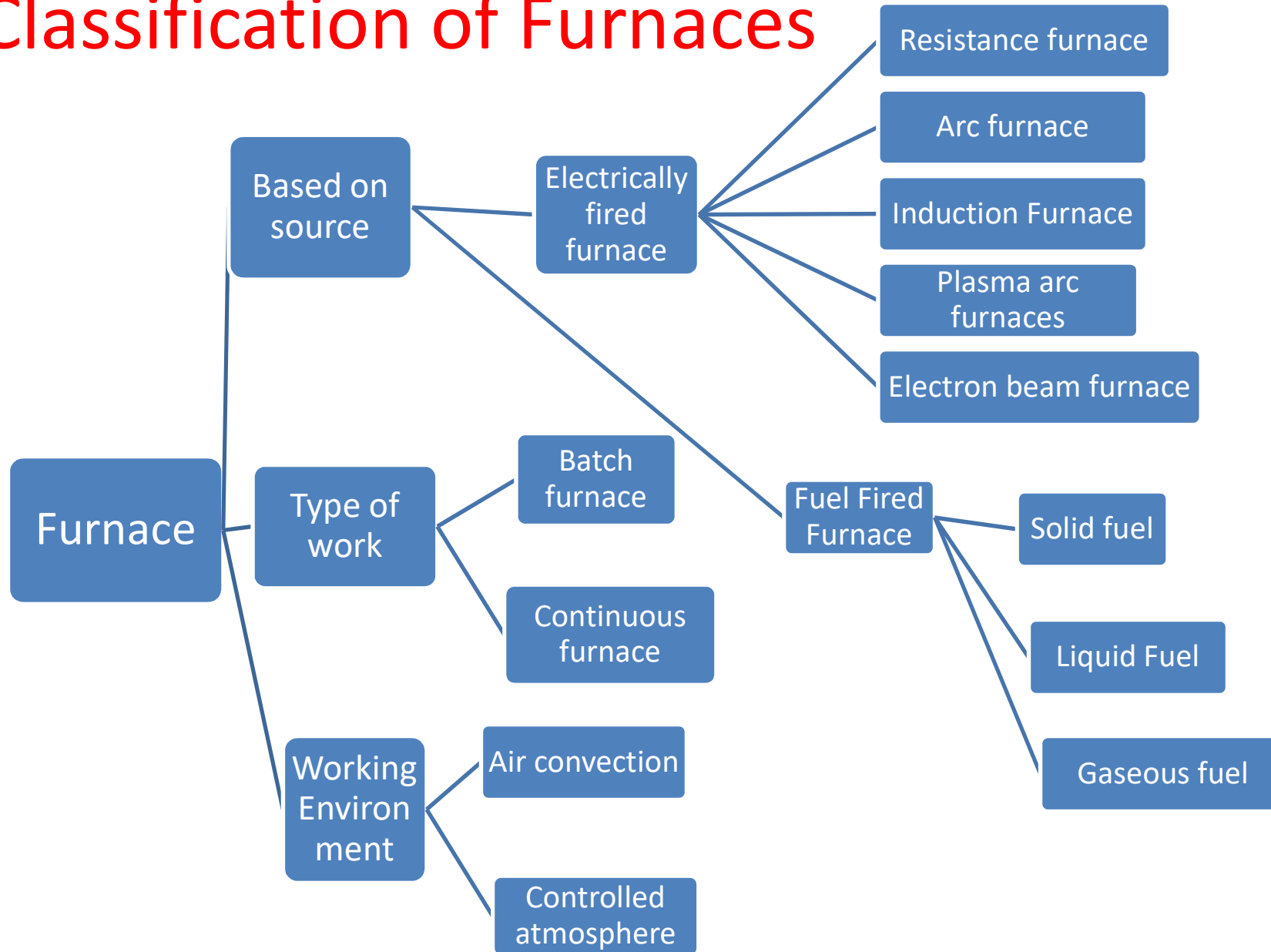

Muffle Furnace

- Muffle Furnace: A furnace, in which the heat source does not directly make contact with the material being heat treated
- Components are heated by gas firing or electrical firing
- Gas firing:
 - Gas fired outside the furnace, hot gases circulate b/w interior-wall and exterior muffle wall.
 - Gas does not contact with the components
- Electrical firing:
 - Nicrome or kanthal wired wound around the muffle
 - High temp: glow bars or radiant elements (components heated by direct radiation)
- Used for annealing, nitriding, carburizing and hardening
- Types:
 - Horizontal muffle furnace
 - Vertical muffle pit furnace

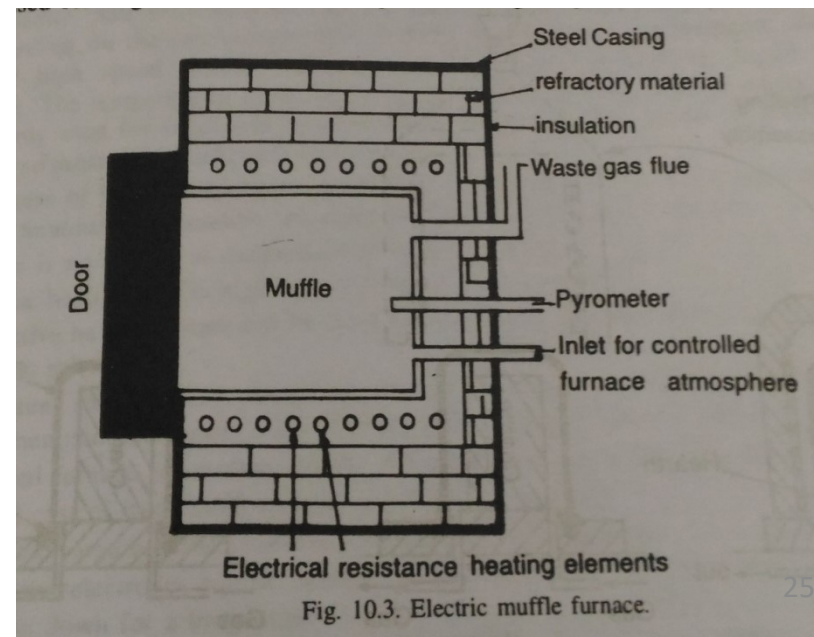
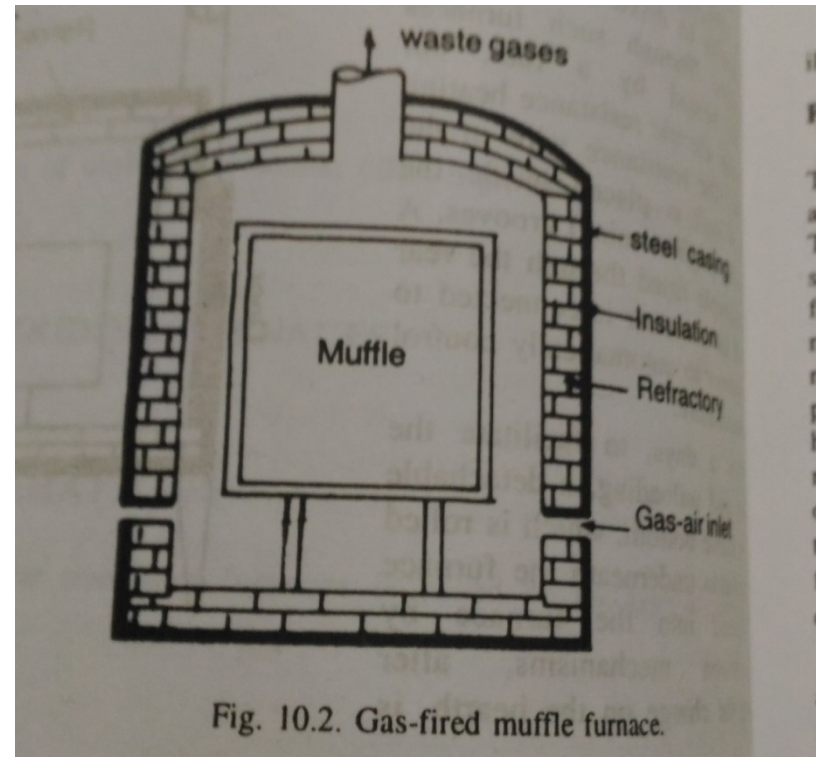

Continuous Furnace

- The components to be heat treated are almost continuously charged at one end of the furnace and then discharged at other end of the furnace after the heat treatment is over.
- It may or may not have controlled atmosphere
- Used for mass production
- Initial cost is high and running cost is low.

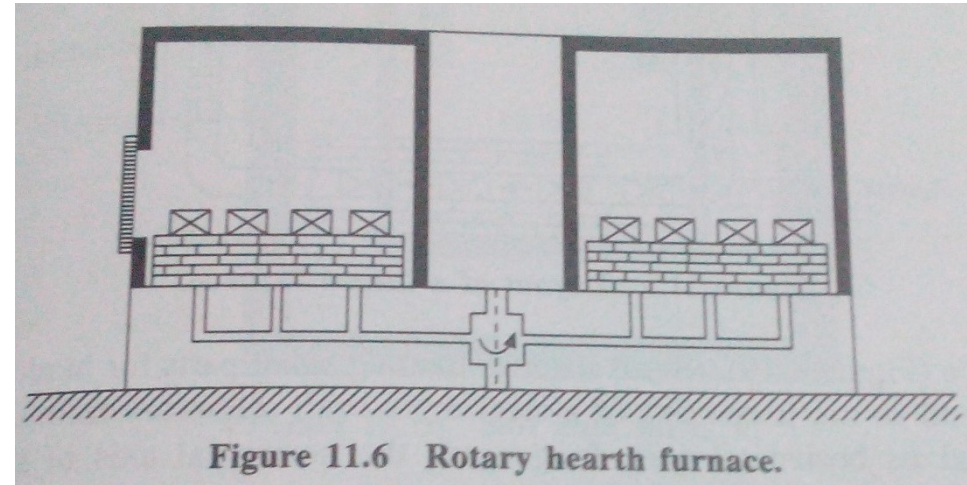

Figure 11.6 Rotary hearth furnace.

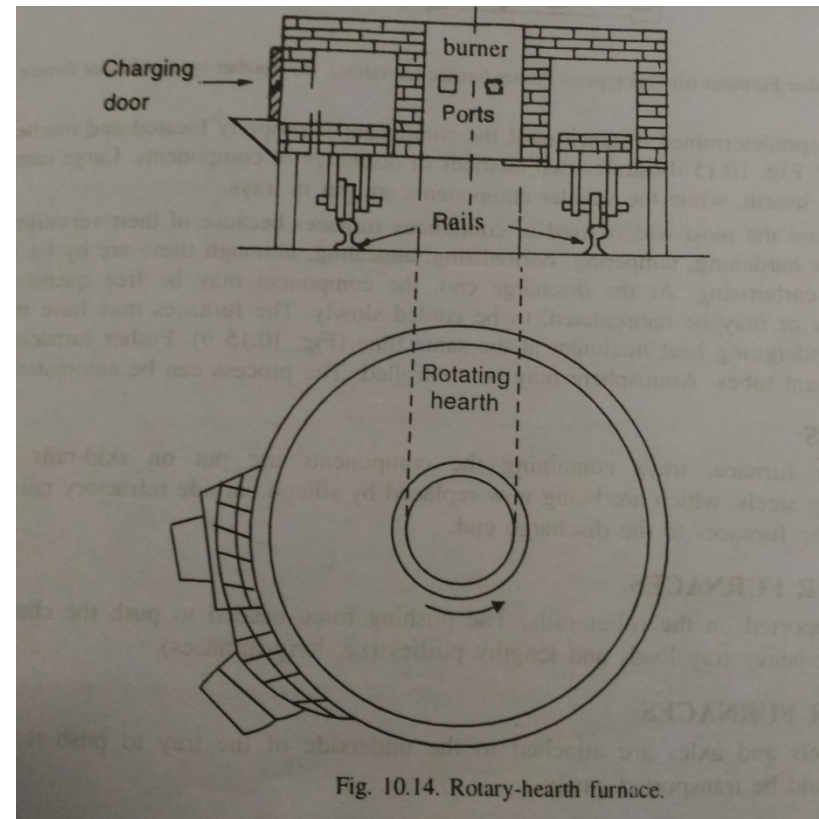
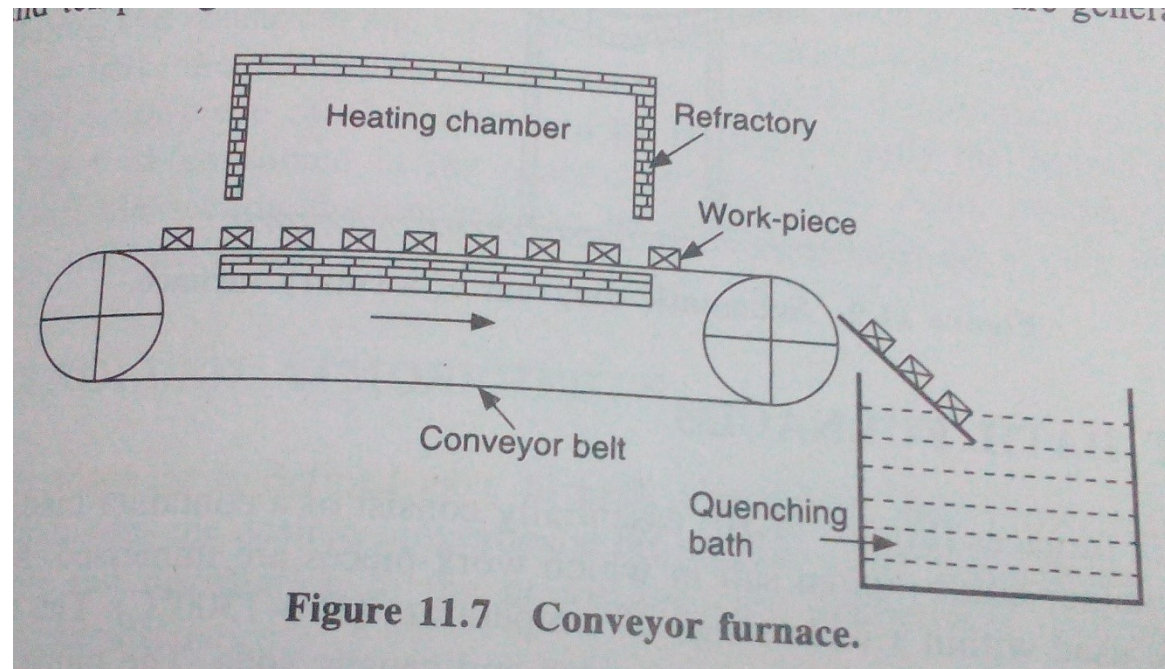
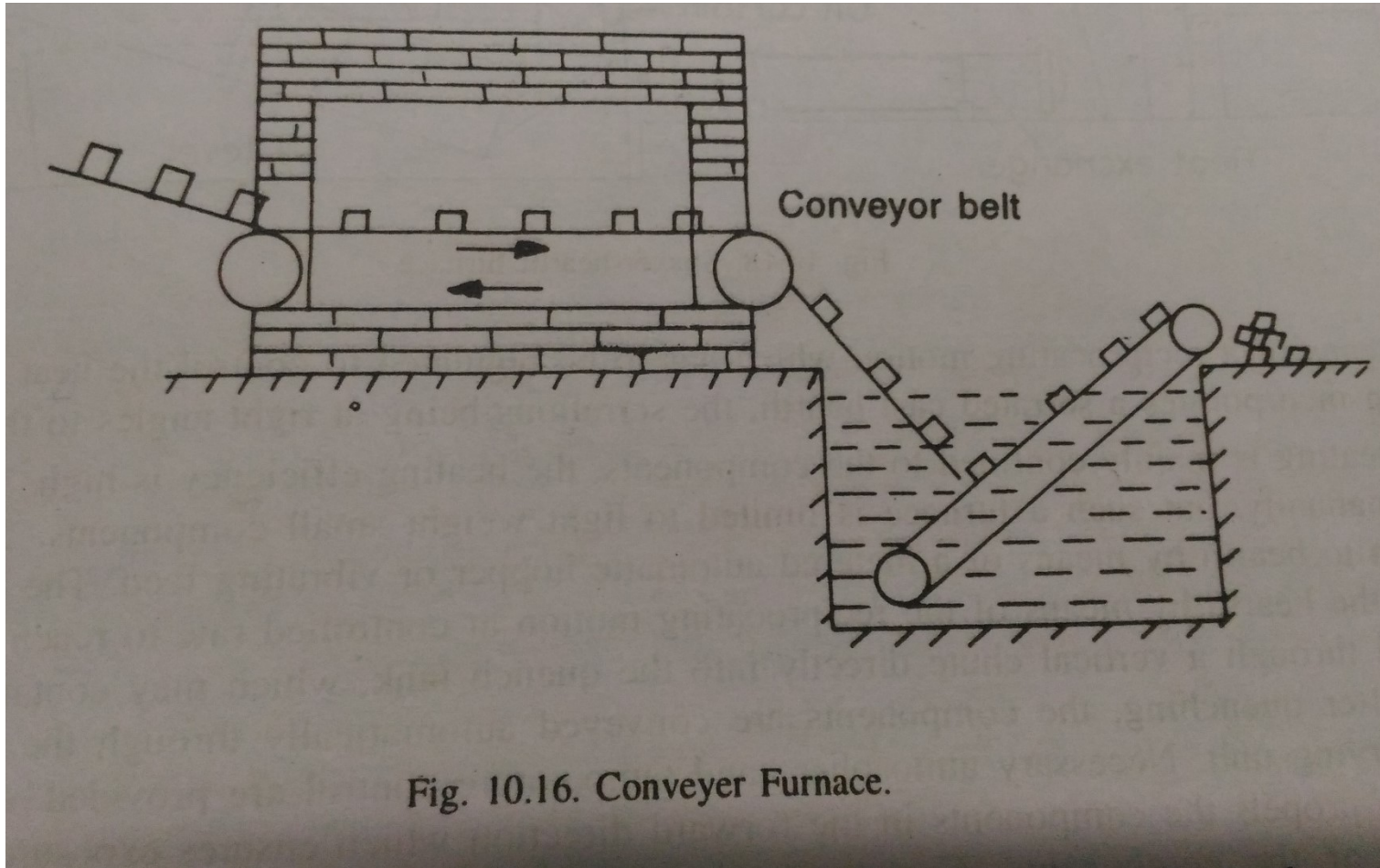

Fig. 10.14. Rotary-hearth furnace.

Conveyor furnace

- Containing endless conveyor belt which move very slow rate.
- Component kept over the belt
- When component moves from one end to other end heating cycle is completed.
- At the end component are collected in box or dropped in to quenching tank.
- Used for hardening and tempering treatment.





Sealed Quench Furnace

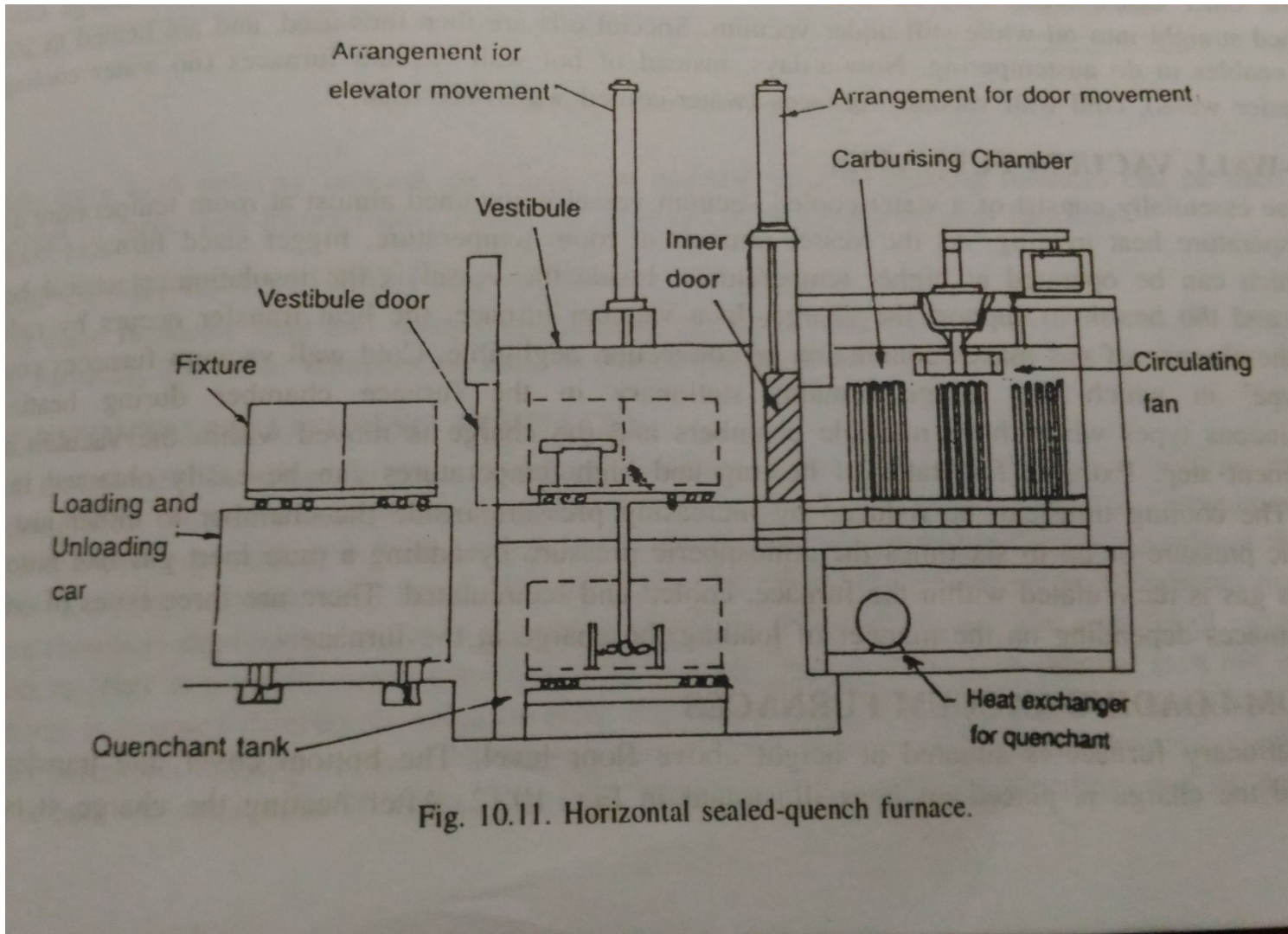

Fig. 10.11. Horizontal sealed-quench furnace.

Sealed Quench Furnace

- Electrically heated, arranged horizontally, having a rectangular shape and have an integral quench tank.
- Components can be loaded as tray, fixtures or baskets
- Atmosphere is maintained by atmosphere panel which consists of flow meter and valves for gases like butane, propane, ammonia or endothermic gas etc.
- Automatic temperature control system controls the temperature
- An external cooler and circulating pump keeps the quenchant in proper temperature
- Batch type furnace
- Atmosphere and temperature are maintained during charging and discharging of work → components are completely scale free.

Advantage:

- Used for bright hardening, bright normalizing, carburizing and carbonitriding
- Components are scale free
- Ideal for producing both shallow cases and deep cases.

Disadvantage

- It is an expensive instrument and also installation process
- Parts which are quenched individually are not suitable for this furnace
- Requires skilled labour

Fluidized-Bed Furnace

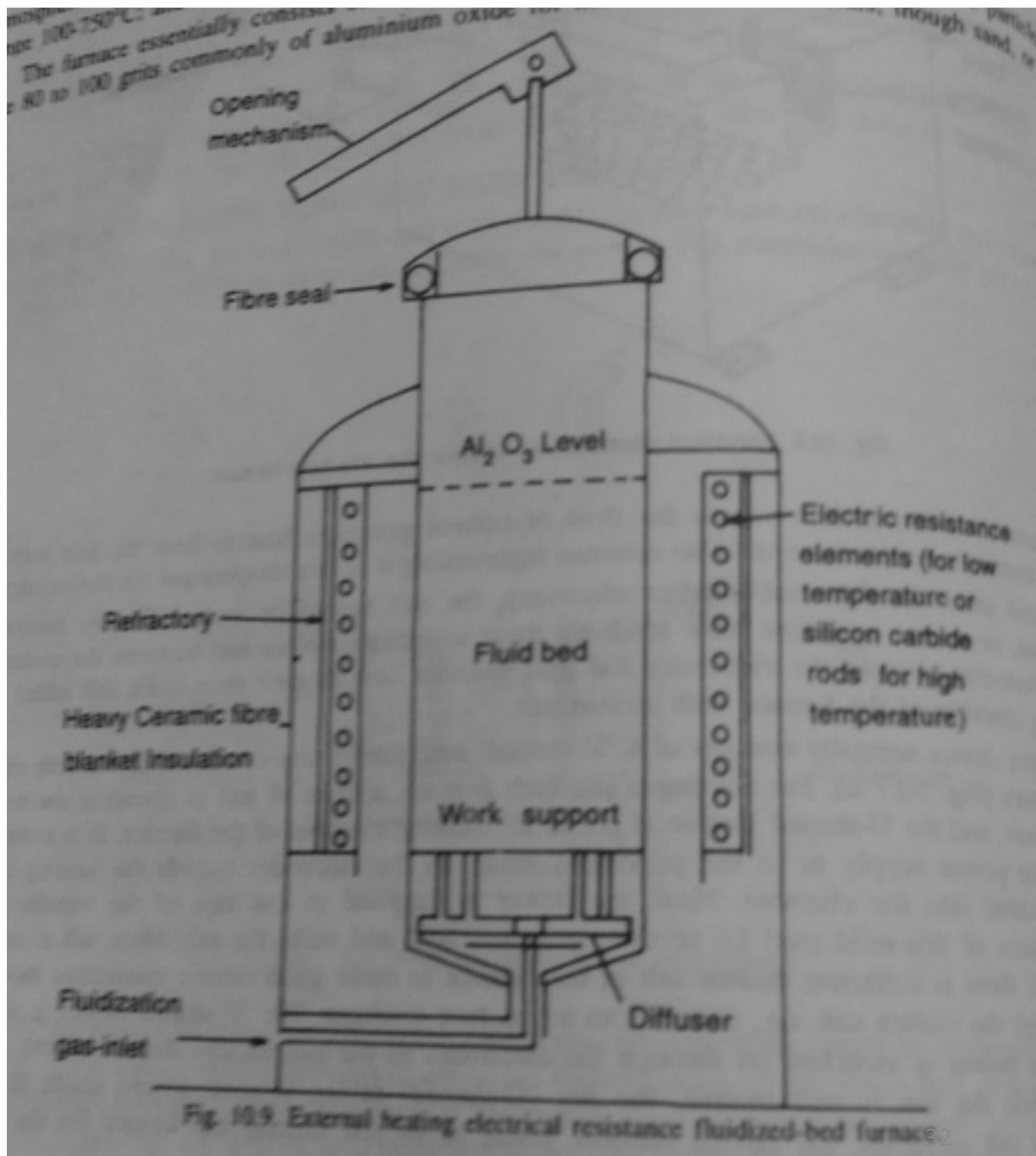

Fluidized-Bed Furnace

- Porous plate above which bed of dry fine particles of sieve size 80-100 grits (Al_2O_3 or sand or ZrO) are used
- The bed is made to act like a fluid by a moving gas fed upwards. It is called as **disperse (or lean) phase fluidized bed** with pneumatic transport of the solids.
- The components are submerged in bed of fine solid particles
- For hardening or tempering: N_2 gas is used
- For carburizing: methanol, N_2 and propane or propane and air mixture
- Types:
 - **External electric-heating fluidized furnace**: furnace heated by external electrical resistance elements or silicon carbide rods.
 - **External gas-fired fluidized furnace**: fuel gas and air mixture burns outside, hot air is allowed to pass b/w external and internal wall
 - **Sub-merged combustion furnace**: product of combustion of fuel are passed through the beds and components which result excellent heat transfer.
 - **Internal combustion gas-fired furnace**: the gas and air mixture are ignited in the bed , generating heat by internal combustion.

Advantage:

- Uniform heat distribution
- High heat transfer efficiency due to turbulent motion and rapid circulation of the particles.
- Various types of atmosphere can be used such as reducing, oxidizing or neutral and carburizing.
- Cheaper to install compare to sealed quench furnace

Disadvantage:

- Large volume of gas (like propane or N₂) are consumed
- Heating duration to achieve required temperature is more
- Skilled labours are required
- Instrument cost is high

Controlled Atmosphere

- Furnace atmosphere which protects the metal from oxidation and maintained desired properties at the surface of the metal during heat treatment.
- Either protective or chemically active atmosphere
- Protective atmosphere → prevent oxidation, decarburization and unwanted chemical changes on the surface of the metal
- Chemically active → carburization, nitriding, chromizing etc.

Chemistry of controlled atmosphere processes

- Controlled atmosphere \rightarrow N_2 , H_2 , H_2O , CO , CO_2 and CH_4 . Trace amount of O_2 and S .
- Reaction take place in furnace are grouped into
 - Reactions between metal and oxygen
 - Reactions between metal and carbon
 - Reactions between gases.

Reactions between metal and oxygen:

These reactions are important to protect the metals from oxidation

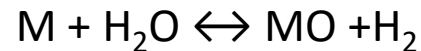

The equilibrium of the reaction are,

$$K_1 = \frac{p_{H_2}}{p_{H_2O}}$$

$$K_2 = \frac{p_{CO}}{p_{CO_2}}$$

K_1 and K_2 are equilibrium constants and p is partial pressure of corresponding phases.

$$K_T = \frac{K_1}{K_2}$$

K_T is equilibrium constant at temperature T . Oxygen dissociation pressure of the particular metal at given temperature plays a major role.

$$\log K_T = -\frac{\Delta G^\circ}{4.576T}$$

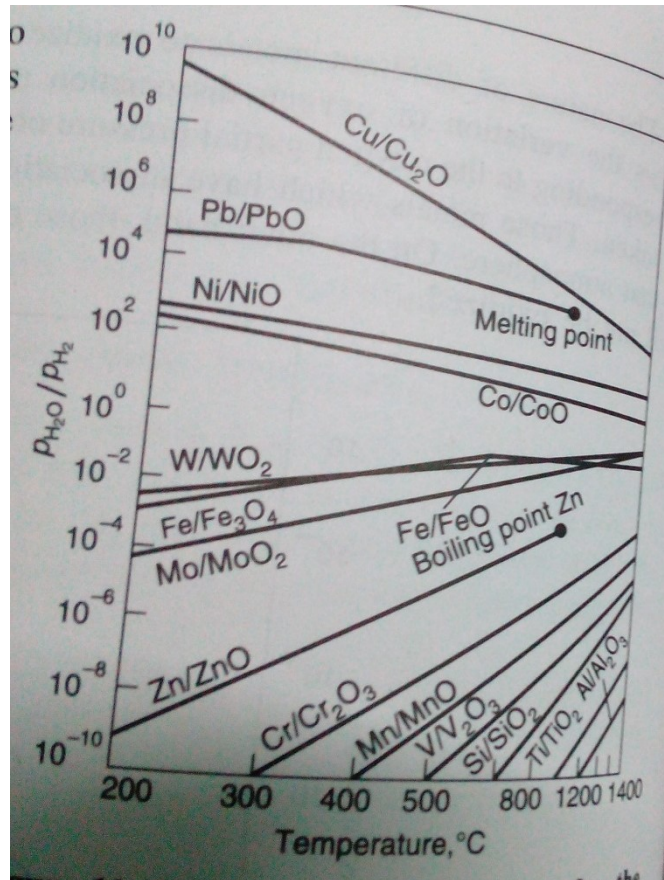

Oxidation of some of the metal with respect to temperature and atmospheres containing water vapour and hydrogen

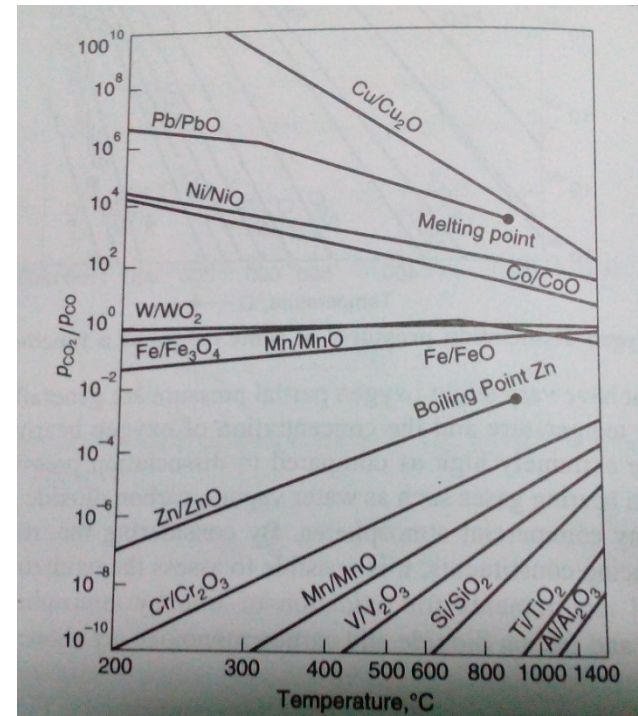

Oxidation of some of the metal with respect to temperature and atmospheres containing CO_2 and CO

Reaction between metal and carbon

- It involves carburization and decarburization
- CO and CH₄ → carburization
- CO₂, water vapour and H₂ → decarburization

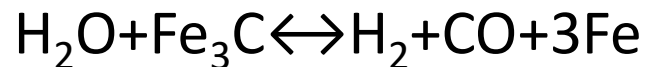
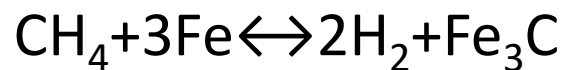

The equilibrium constants are

$$K_3 = \frac{p_{\text{CO}_2}}{p_{\text{CO}}^2} \quad K_4 = \frac{p_{\text{H}_2}^2}{p_{\text{CH}_4}}$$

For non-ferrous

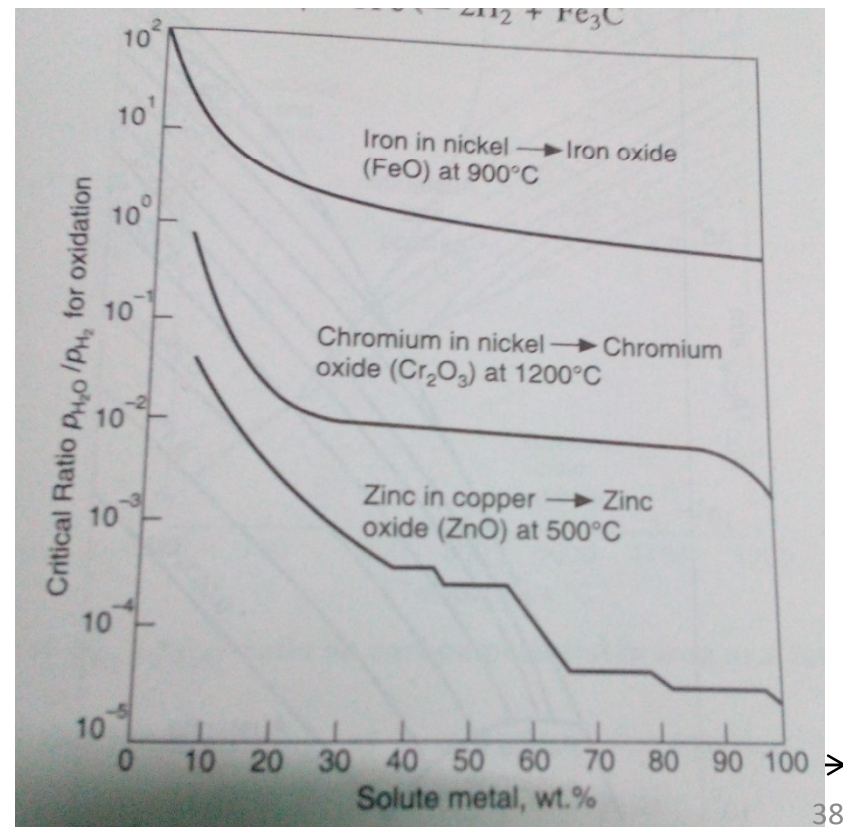
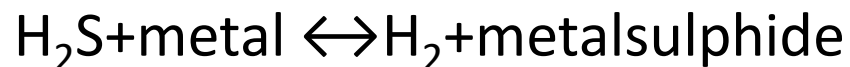

Reaction between gases

- Atmosphere containing O_2 , C and H_2 → used to bring changes in composition to attain equilibrium.
- CO → greater affinity to O_2 at low temp.
- H_2 → greater affinity to O_2 at high temp.
- At $850^\circ C$, CO and H_2 affinity towards O_2 is equal
- Atmosphere have H_2O then CO conc. ↓ es at low temperature.



Commercially available atmosphere

- Town gas or other fuel gas
- Ammonia
- Charcoal
- Liquid organic mixtures (alcohol base for carburizing)
- Vacuum

Town gas:

- Cheap and easily available gas
- Burning of fuel gas with varying amount of air
- Two types
 - Exothermic
 - endothermic

Exothermic atmospheres:

- Partial combustion of town gas, propane in presence of air followed by condensation of excess water vapour
- Range of atmosphere compositions are produced. 5-14% CO₂, 1-14% CO, 1-18% H₂ and 0-2% CH₄
- Temperature of cooling water determines the content of H₂O (correspond to dew point 5-25°C)

- By adjusting air to gas ratio
 - Lean (totally burnt) exothermic atmosphere
 - Used for non ferrous alloys like annealing of Cu (removal of S is necessary)
 - Rich (flammable) exothermic atmosphere
 - Used for HT of steel like bright annealing, normalizing and tempering
- Low carbon potential → presence of CO_2 → decarburization take place → CO_2 and H_2O removed from the atmosphere.
- Technique used to remove CO_2 :
 - Mono ethanamine (MEA) method
(MEA adsorbs CO_2 and S gases)
 - Using high pressure water
 - Molecular sieves method
(granulated artificial zeolite gases absorb CO_2 and water)

Endothermic atmosphere

- Produced by hydrocarbon containing fuel gases which is sufficient to oxidize the hydrocarbon to CO and H₂.
- The below reactions carried out at 1075°C in presence of Ni catalyst

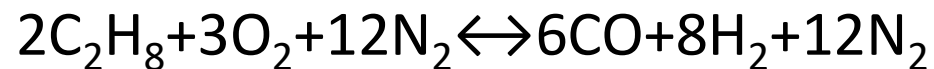
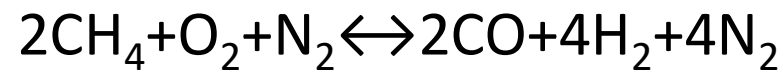

- Externally heat is supplied to maintain the temp.
- High carbon potential → low amount of CO₂ is present → concentration varied by gas to air ratio
- Used for heat treatment with out decarburization

Ammonia Based atmosphere:

- Unhydrous NH_3 under go dissociation into 25% N_2 and 75% H_2 when it pass over the catalyst
 - Catalyst: Fe at 560°C and Ni at 900°C
 - Dew point for cracked ammonia is -15 to -40°C
- Burned NH_3 : $\text{NH}_3 + \text{air} \rightarrow \text{N}_2 + \text{H}_2 + \text{H}_2\text{O}$
 - Catalyst: Ni at 850°C
 - Dew point : $+5$ to -70°C
- For strip and wire \rightarrow burnt NH_3
- Stainless steels and other applications \rightarrow cracked NH_3

Charcoal

- Used to produce atmosphere by combustion with air and flue gas.
- The gaseous product contains CO_2 , CO , H_2 and CH_4
- Produce high carbon potential.
- cumbersome due to operating conditions

Liquid Organic mixtures:

- Produce very high carbon potential when alcohol base organic mixtures used in furnace

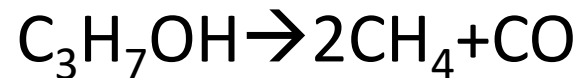

- Mostly used: methanol or propanol + benzol or dipentene

Vacuum:

- Most suitable protective atmosphere.
- Vacuum: 5-30mm of Hg → strip or wire
μm → stainless steel and heat resistant steel

Control of furnace atmospheres

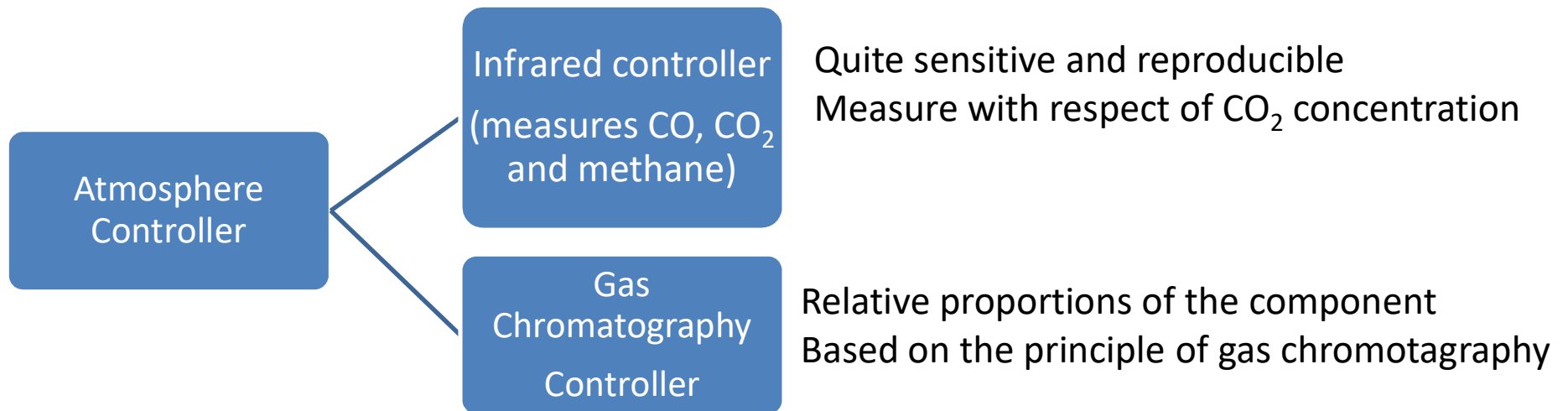

Temperature Measurement Control Devices

- To control the temperatures within definite limits for certain periods of time
- Temperature can be controlled manually or automatically
- Electric resistance furnace → Manual controlled with the help of rheostat
 - By varying resistance → the power supply to the furnace controlled → temperature of the furnace
- Fuel fired furnace → manual control
 - Using the rate of fuel air control → regulate the temperature
- Most of the other furnace → automatic temperature controller is used

Automatic Temperature Controller

- On and off controller → automatic shut-off of power supply when temperature reaches → when temperature goes down automatic on of power supply

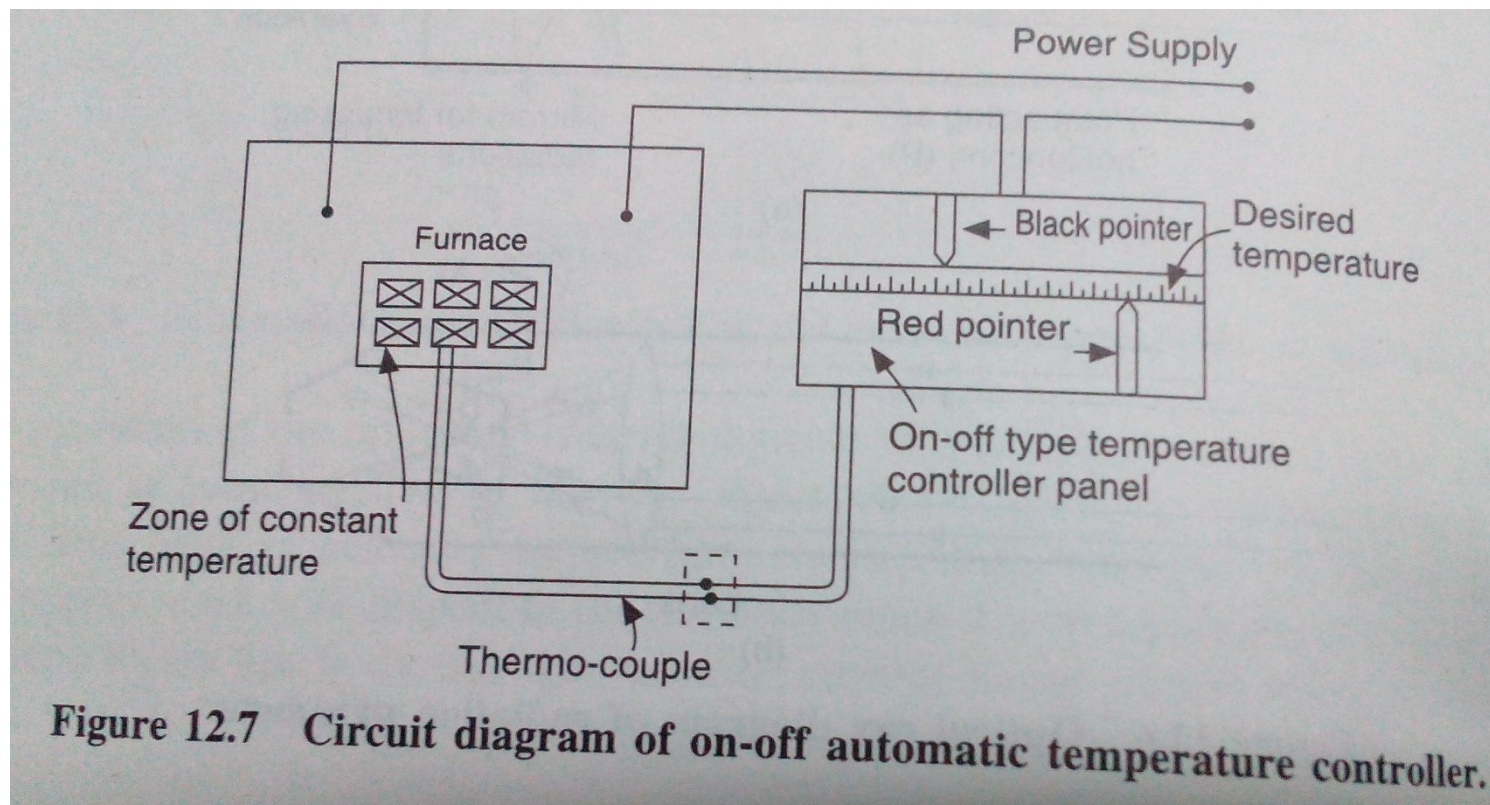

Table 12.1 Chemical Composition of Some Alloys Used as Thermo-couple Wires

Name of the alloy	Chemical composition
Constantan	Cu, 40% Ni
Chromel	Ni, 10% Cr
Alumel	Ni, 3% Mn; 2% Al; 1% Si
Pt-Rh alloy	Pt, 10% Rh or 13% Rh

Table 12.2 Melting Points of Some Refractory Metals

Metal	Melting Point (°C)
Tungsten	3410
Tantalum	2996
Molybdenum	2617
Rhenium	3180
Niobium	2468
Iridium	2410
Ruthenium	2310

The following combinations of these metals/alloys are quite popular:

- (i) Tungsten-molybdenum
- (ii) Tungsten-rhenium
- (iii) Tungsten-tungsten and 26 percent rhenium
- (iv) Tungsten and 6 percent rhenium-tungsten and 26 percent rhenium
- (v) Molybdenum-rhenium
- (vi) Tungsten-iridium
- (vii) Iridium-iridium and rhodium alloys.

Table 11.1 Resistors Used in Electrical Resistance Furnaces

Name	Composition	Maximum working temperature (°C)
Constantan	Cu, 40% Ni	900
Nichrome I	Ni, 20% Cr	1100
Nichrome II	Ni, 24% Fe; 16% Cr	950
Alumel	Ni, 3% Mn; 2% Al; 1% Si	1200
Chromel	Ni, 10% Cr	1200
Chromel C	Ni, 23% Fe; 15% Cr; 2% Mn	900
Kanthal	Fe, 25% Cr; 5% Al; 3% Co	1400
Tungsten		2400
Molybdenum		1800
Tantalum		2200
Platinum		1500
Pt-Rh alloy, Pt, 10% Rh		1700
Thoria		2400
Graphite		2000

Types of cast iron

- White cast iron - carbides, often alloyed
- Grey cast iron - carbon in the form of graphite
- Ductile cast iron
 - Nodular/spheroidal graphite
- Malleable cast iron
 - Graphite in nodular form

Effect of cooling rate

- Slow cooling favours the formation of graphite & low hardness
- Rapid cooling promotes carbides with high hardness
- Thick sections cool slowly, while thin sections cool quickly

White Cast Iron

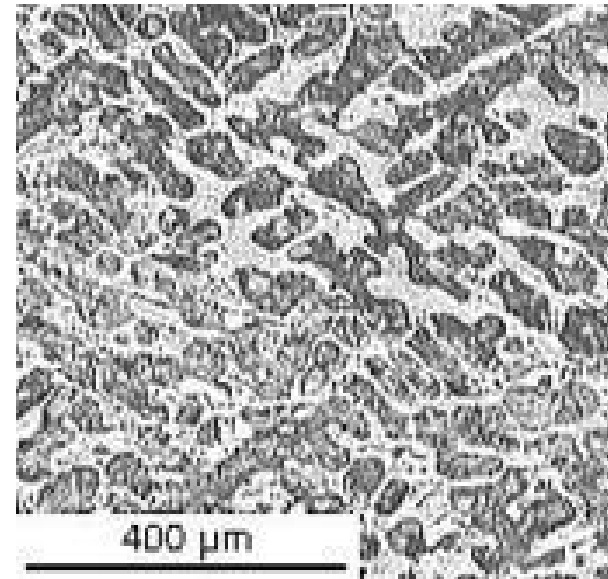
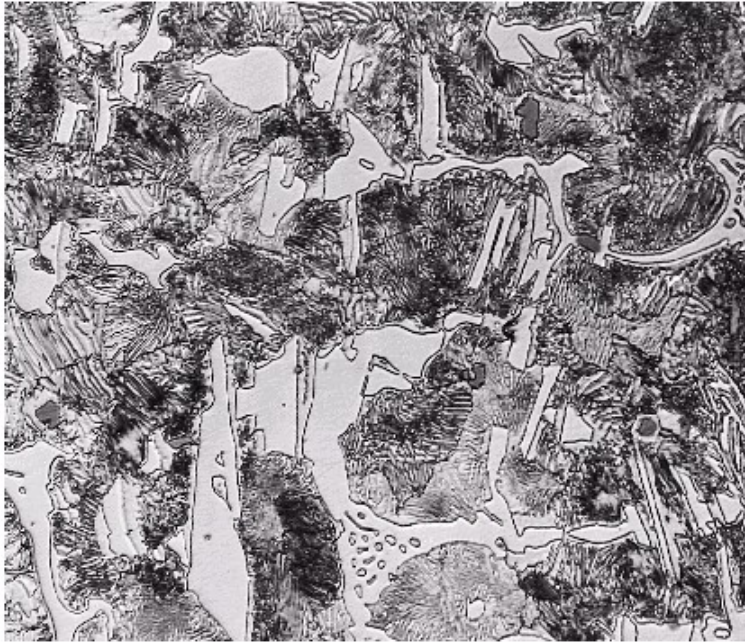

Malleable Iron

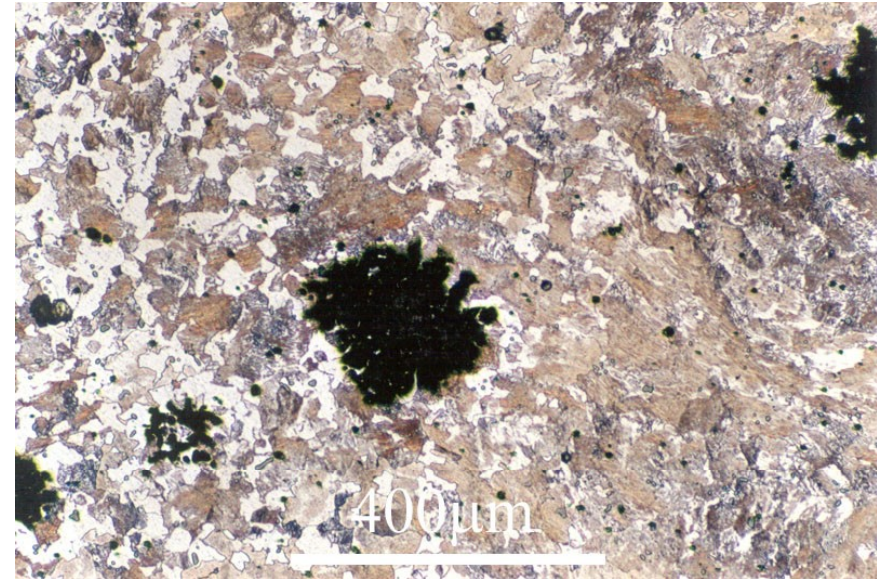

Graphite in nodular form

Produced by heat treatment of white cast iron

Graphite nodules are irregular clusters

Grey Cast Iron

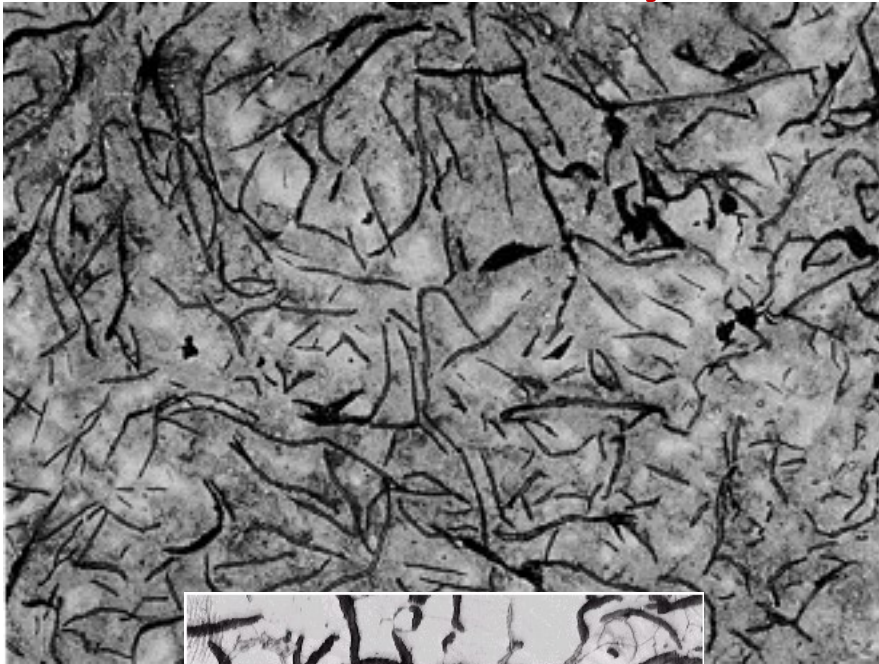

Carbon : Graphite flakes

Matrix: Pearlite or ferrite

Transform to ferrite when Cooling rate is slow

High silicon content

Machineability is excellent

Ductility is low

impact resistance low

Damping capacity high

Thermal conductivity high

Excellent wear properties

Nodular / spherical Cast iron

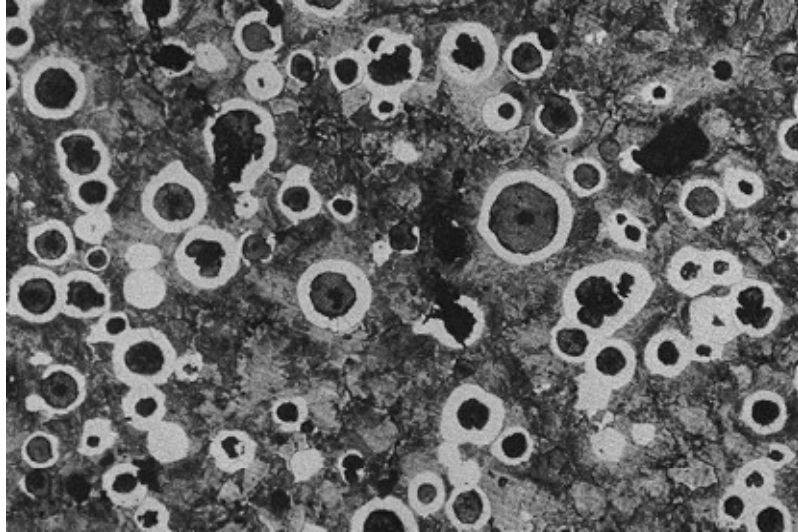

Inoculation with Ce or Mg or both causes graphite to form as spherulites, rather than flakes

Also known as spheroidal graphite (SG), and nodular graphite iron

Far better ductility than grey cast iron

- Strength higher than grey cast iron
- Ductility up to 6% as cast or 20% annealed
- Low cost
- Machineability better than steel

Production of Cast Iron

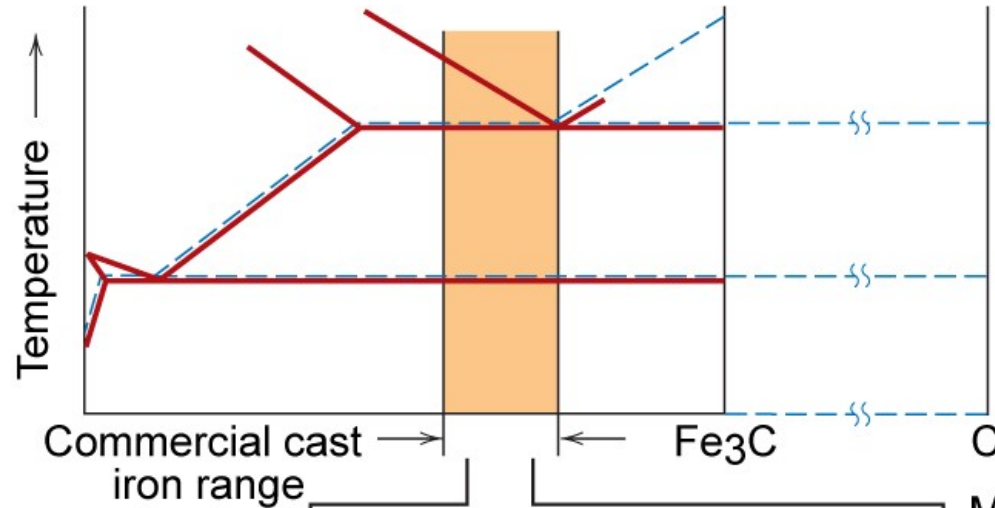

Reheat: hold at $\sim 700^\circ C$ for 30 + h

Fast cool	Slow cool
$P + G_r$	$\alpha + G_r$

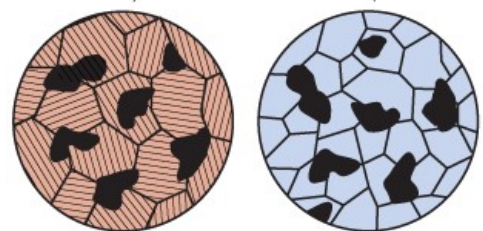

Pearlitic malleable Ferritic malleable

Fast cool	Moderate	Slow cool
$P + Fe_3C$	$P + G_f$	$\alpha + G_f$

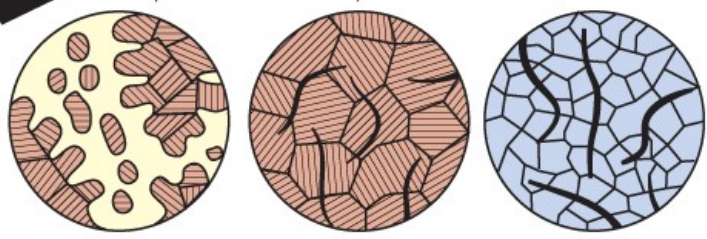

White cast iron Pearlitic gray cast iron Ferritic gray cast iron

Moderate	Slow cool
$P + G_n$	$\alpha + G_n$

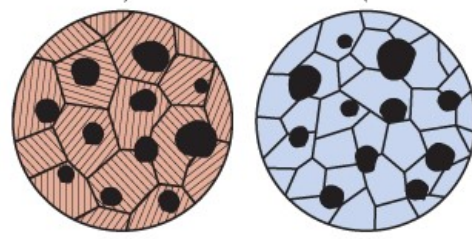

Pearlitic ductile cast iron Ferritic ductile cast iron

White Cast Iron

- White cast iron = Ferrite + network cementite
- Fractured surface appears white
- Brittle, hard and wear resistant
- Poor machinability
- Used for manufacture of malleable cast iron by graphitizing annealing treatment
- Pouring molten cast iron in metallic mold → out surface white cast iron + inner surface graphitic in nature.
 - Transition zone = both white cast iron and graphite → mottled cast iron
 - During solidification, high internal stress developed due to varying cooling rate across the cross section.
 - These stresses are relieved by heating about 500-550°C

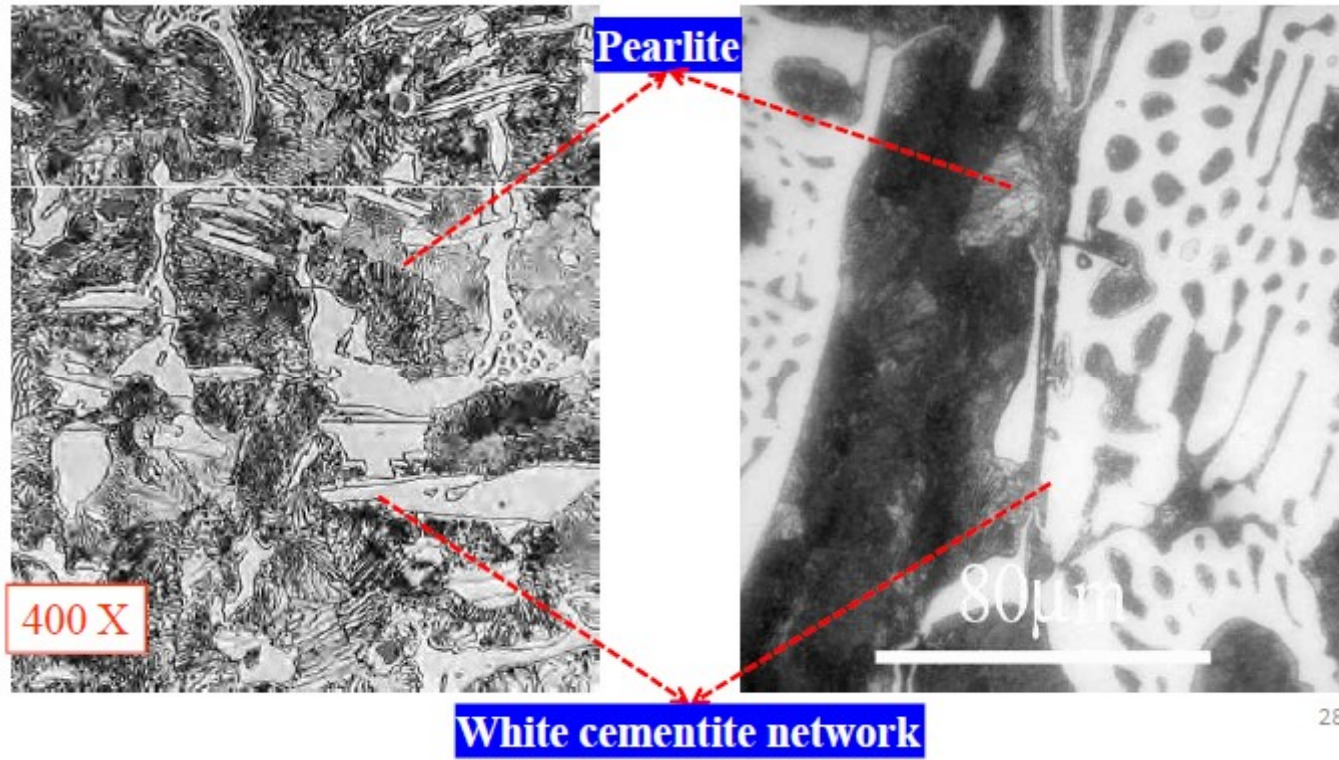

282

Malleable Cast Iron

- Composition of Si and C are adjusted
- C → 2.2 to 2.8% and Si → 0.8 to 1.5%

Types:

- Based on phases
 - Ferritic or standard malleable cast iron (Fe matrix + graphite)
 - Pearlitic or alloyed malleable cast iron (pearlite matrix + graphite)
 - Martensitic malleable cast iron (Martensite matrix + graphite)
- Based on fracture surface
 - White heart malleable cast iron (fractured surface appear white)
 - Black heart malleable cast iron (fractured surface appear black)
- Ductile, shock resistant and machinable

Malleable Cast Iron

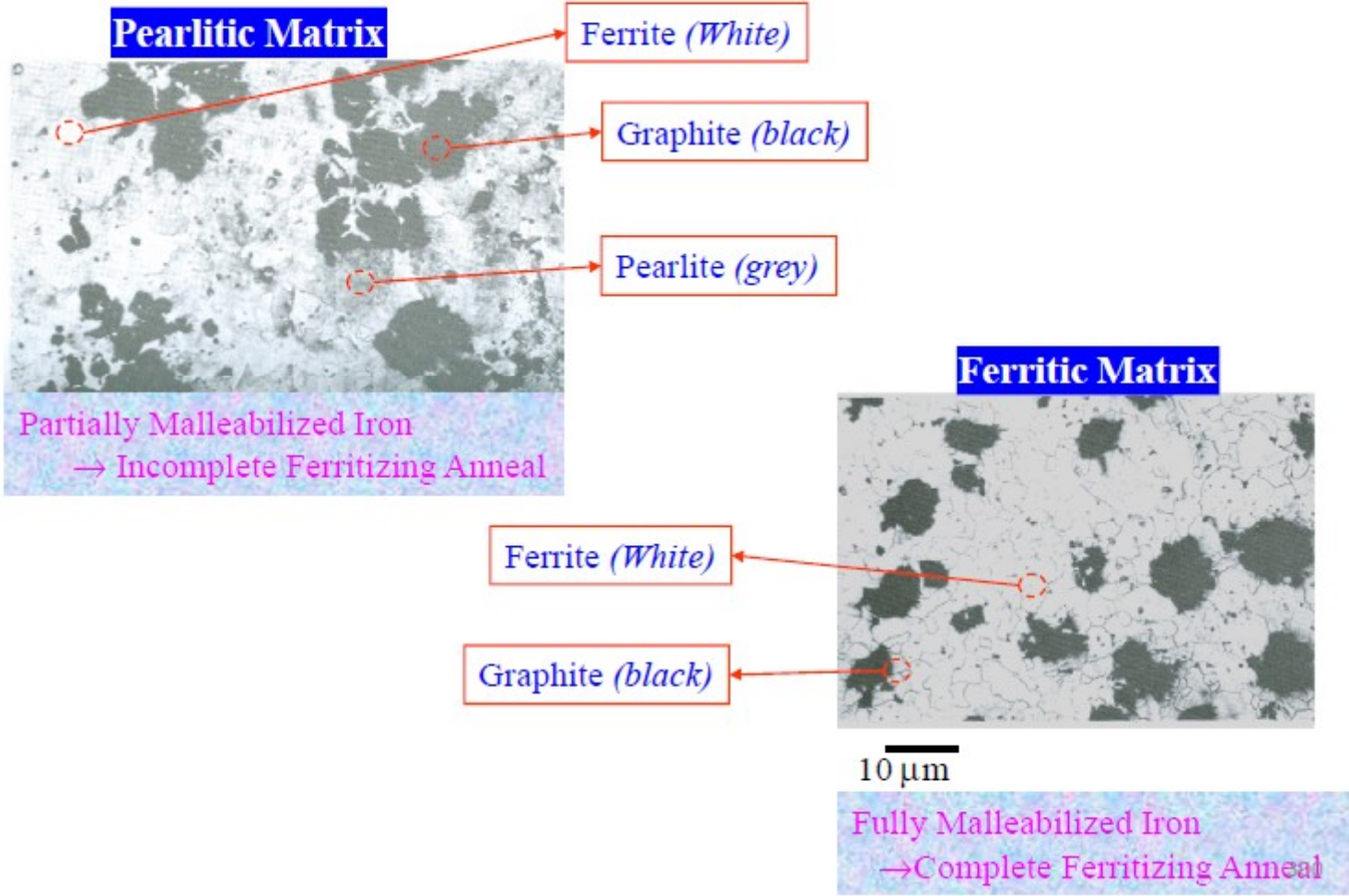

Malleabilization of White Cast Iron

- *Controlled annealing heat treatment of white cast iron is called as malleabilization*
- Heat treatment involves 3 steps.

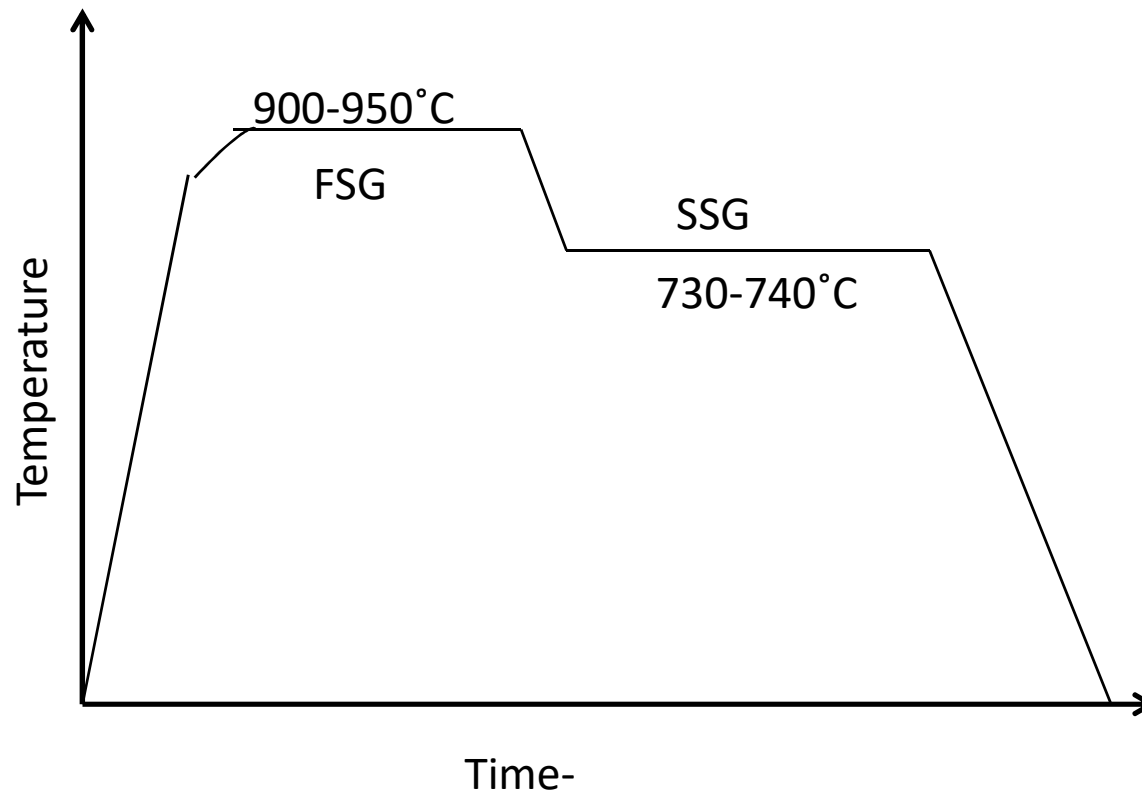

- Step 1
 - Nucleation of graphite: occurs at heating to high temperature and very beginning of holding time.
 - Depends on heating rate, section size, chemical composition, pre-heat treatment and presence of trace elements
- Step 2: First Stage of Graphitization (FSG)
 - Holding the casting at 900-950°C (Duration 20 to 70 hours)
 - Pearlite + Fe₃C → saturated austenite + temper C (irregular nodules or spheroids)
 - FSG breaks all cementite phase
 - Time duration depends on number of nuclei, solution of carbide and diffusivity of C
 - Castings rapidly cooled to 740 to 730°C before SSG (takes 2 to 6 hours).
- Step 3: Second Stage of Graphitization (SSG) or Second stage of annealing
 - Holding the casting at 740 - 730°C
 - Austenite + temper carbon → Ferrite + Graphite
 - Very slow cooling rate (1.5 to 12°C/hour)

Malleabilization of White Cast Iron

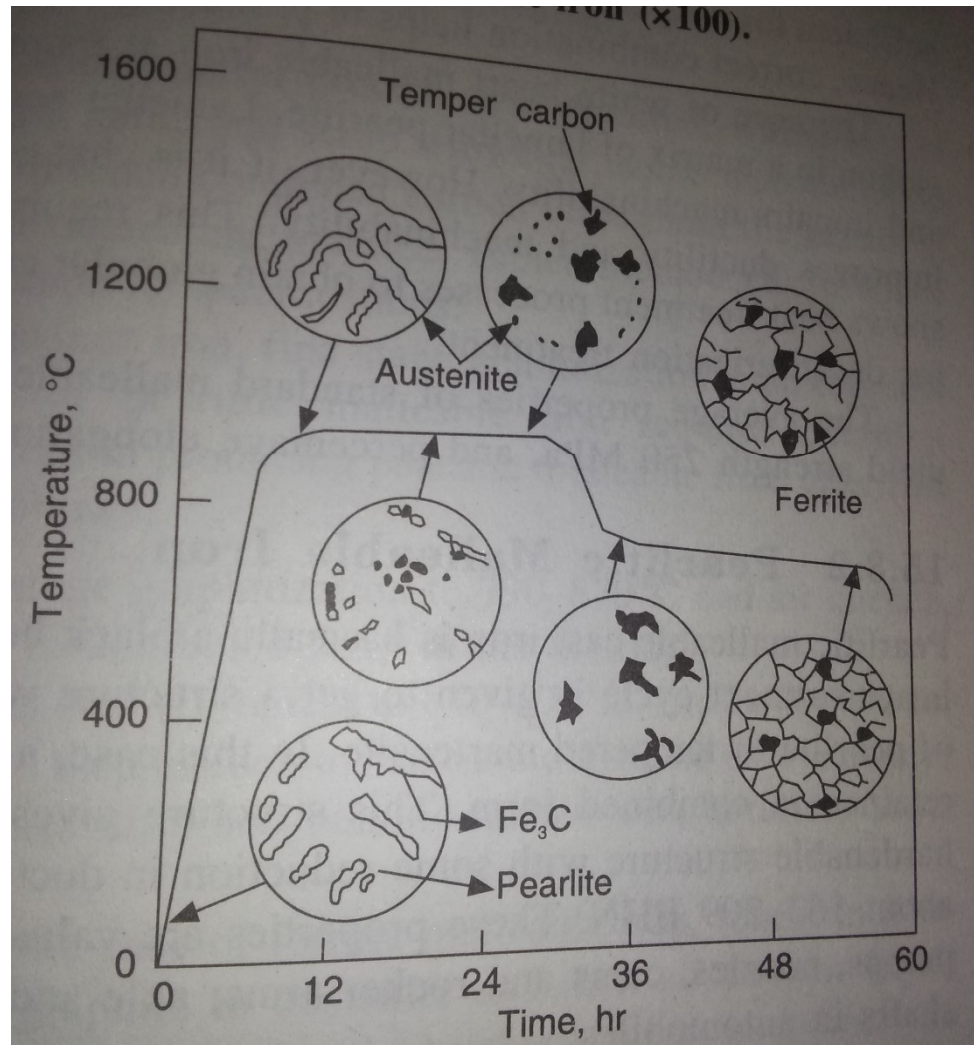

- **Black Heart Process:**
 - Component packed in heat resistant box with sand which serves as filler and excludes air (reducing atmosphere)
 - The above mentioned process is black heart process
- **White heart process:**
 - Components are packed in heat resistant box with iron oxide (Decarburizing atmosphere).
 - Scale formation does not take place.
 - Core: temper C in lamellar pearlite (not desirable)
 - Case: graphite in Ferrite
 - Additional treatment required to convert lamellar pearlite into ferrite and globular cementite

Pearlitic Malleable Iron

- Basically a black heart malleable cast iron
- Temper C in pearlite or tempered martensite
- C (0.3 to 0.9%) retained in combined form
- High TS, reasonable ductility
- Mn added to retain combined C in the matrix
- Process 1: After FSG following methods are used
 - i. Reheat to 790-870°C followed by air cooling (Pearlite + ferrite + nodular C → bull's eye structure)
 - ii. After (i) step, reheat to 840-870°C and hold for 1 hour to re-austenize followed by quenching in agitated oil(85-100°C). Resultant phase: Martensitic and Bainitic matrix
 - iii. Reheat to 840-870°C followed by soaking (to dissolve graphite in austenite) and air cool or liquid quench which hardness less than (i) (ferrite + nodular C)

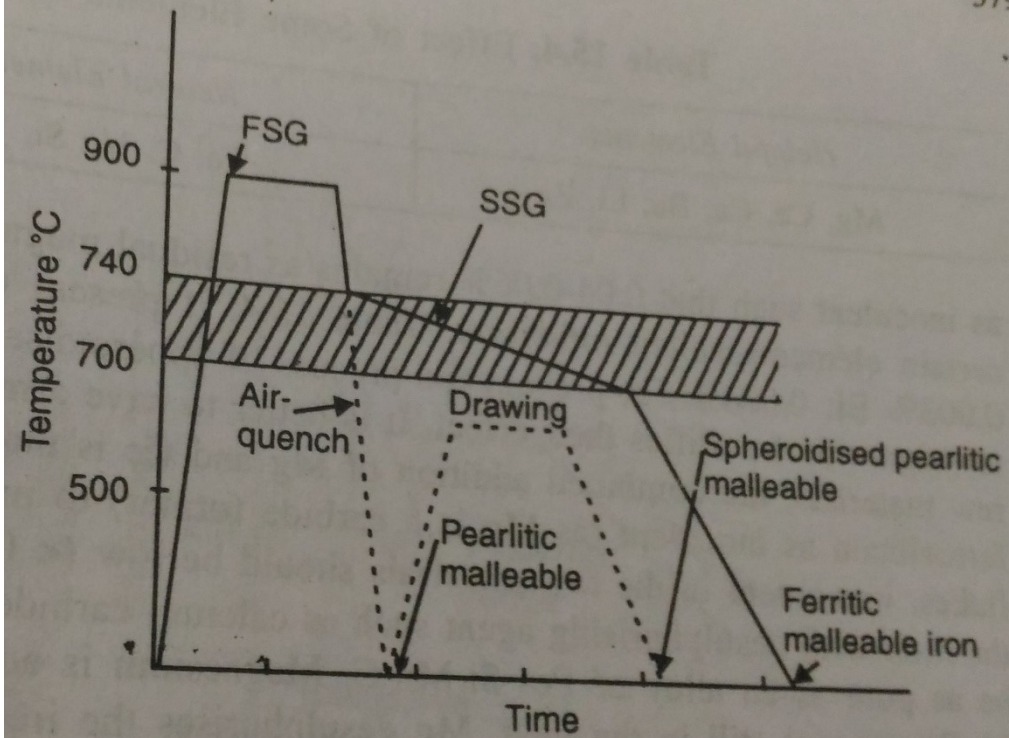
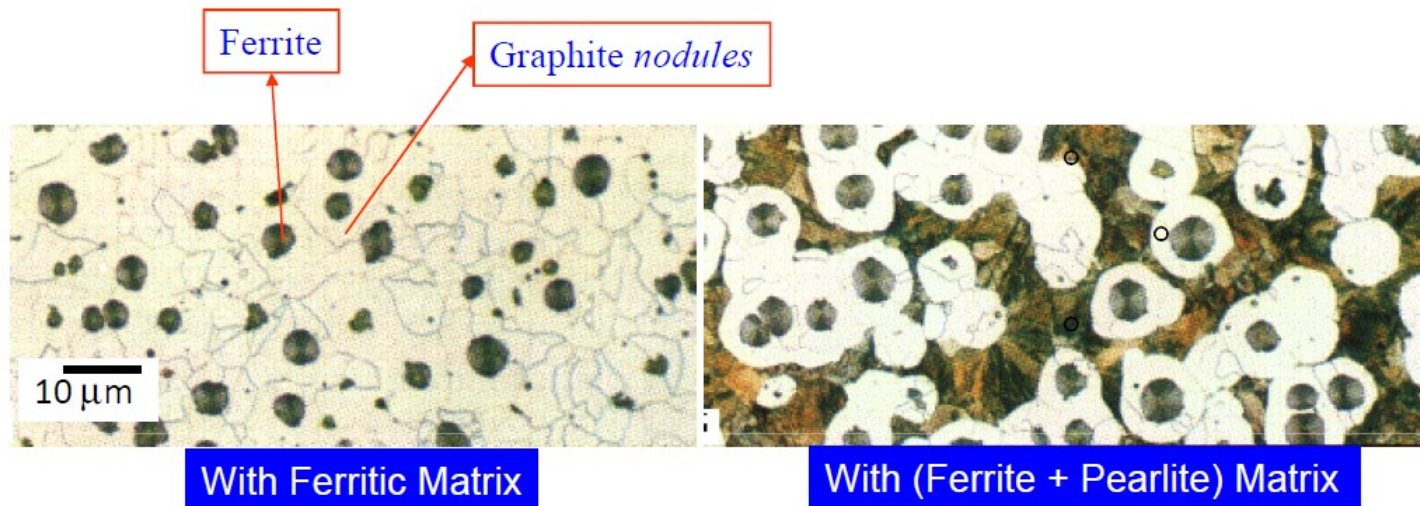

Fig. 15.8. Typical malleablising cycle. FSG is first stage graphitisation at the annealing temperature; SSG is second stage graphitisation when casting cools from around 740°C to 700°C

Spheroidal Graphite (SG) Iron

- Also called an nodular iron or ductile iron
- Mechanical properties are superior than grey cast iron
- Condition: Very low S and P content (0.04% max.)
- Obtained by addition of **Modifier** such as Mg or Ce in liquid metal in ladle
- Graphitizer: Ni, ferrosilicon
- Modifier:
 - cause the graphite to precipitate in all direction as spheroidal.
 - Increases the supercooling of cast iron (chilling)
- Heat Treatment
 - Stress relieving
 - Annealing
 - Normalizing
 - Hardening and tempering
 - Surface hardening
 - Austempering

Ductile Cast Iron : Spheroidal Graphite (SG) iron



Stress Relieving:

- Reduce Internal stress
- Reduces warping and distortion during subsequent machining.

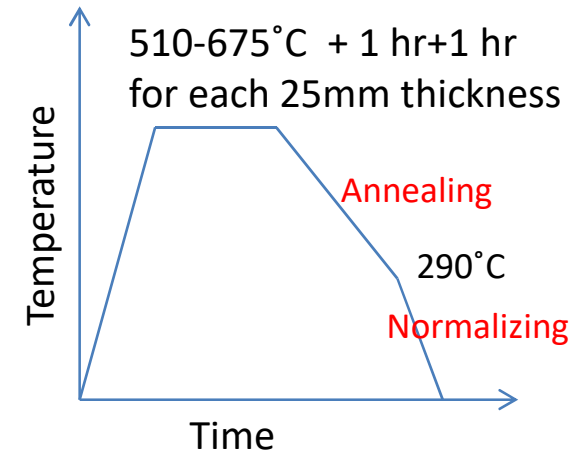

Annealing:

- Full ferrite phase is obtained by this method
- Annealing used to remove carbides and stabilized Pearlite (Ferrite + graphite nodules)
- Maximum ductility and good machinability
- Alloying element Mn, P and Cr, Ni & Mo should be as low as possible
- Carbide formers take long time to decompose. (Cr_xC_y decompose at 925°C)

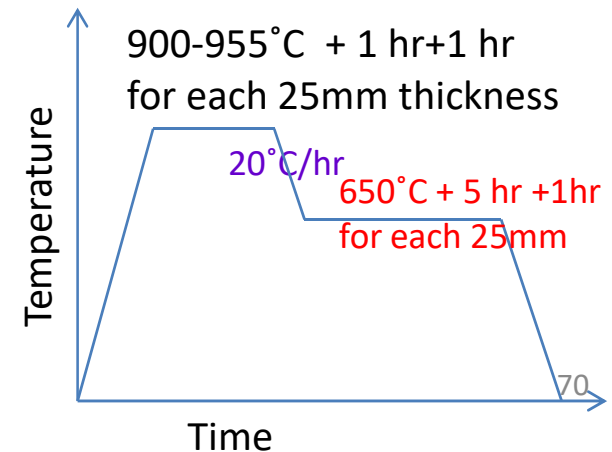
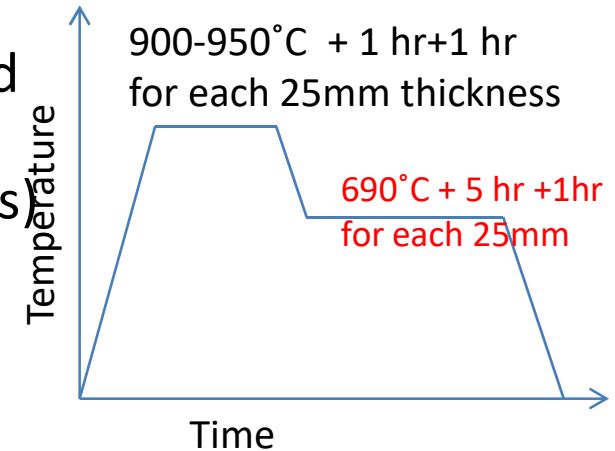

Normalizing

- Improves TS
- Temp. and soaking time vary with composition, especially Si and Cr content.
- Normalizing followed by tempering to improve toughness and impact resistance
- Alloy: Ni, Mo and Mn helps for formation fully pearlitic matrix
- Martensite matrix is obtained for alloyed casting

Hardening and Tempering

- Quenching medium: oil /hot oil (80-100°C)
- Martensitic Matrix.

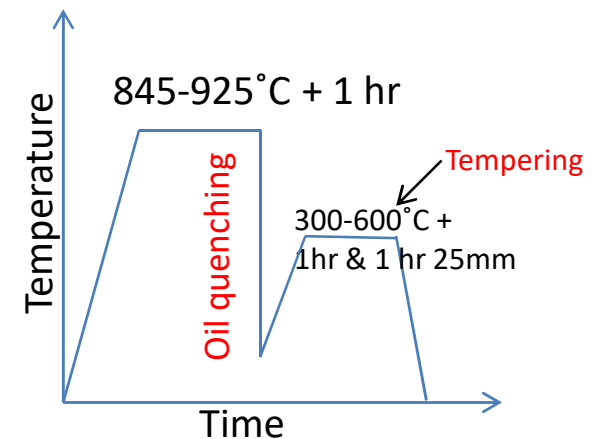
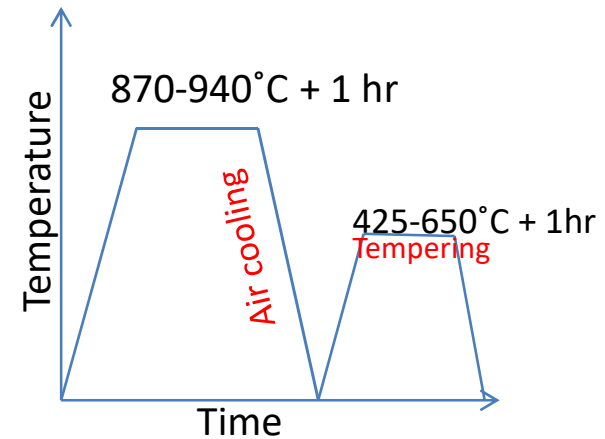

Surface Hardening:

- Flame or induction hardened.
- Pearlitic SG iron preferred due to low time for austenitizing.
- Pre heat treatment required
- Tempering (595-650°C for 1hr +1 hr for 25mm) to remove internal stress before going for surface hardening

Austempering

- High range of TS and elongation are obtained
- Only for defect free SG iron (otherwise heat treatment process will be waste)
- Bainite Matrix is obtained
- Machined before heat treatment

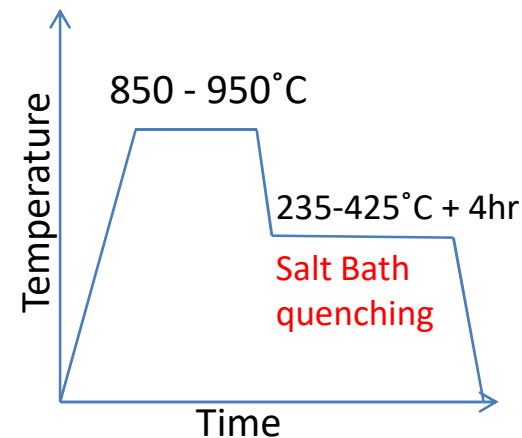

Advantages:

High strength and ductility , High wear resistance, High toughness, Better machinability
Higher damping capacity and Reduced weight in comparison with steel

Applications:

Pump castings, plough shears in agriculture & forestry , friction blocks and locomotive wheels, conveyor rollers and blades etc.

Grey Cast Iron

- Gray cast iron is obtained by cooling the molten metal slowly during solidification.
- A typical gray cast iron contains 2.5-3.5% C, 1.4-2.8% Si, 0.5-0.8% Mn, 0.1-0.9% P, and 0.06-0.12% S.
- Fractured surface of gray cast iron appears grey because of the presence of graphite. → grey cast iron
- By alloy addition or controlling cooling rate, $\text{Fe}_3\text{C} \rightarrow \text{C} + \text{Fe}$ (ferrite or austenite)
- During cooling initially it forms as austenite and cementite which later undergo dissociation due to alloying element, C amount and cooling rate follows Fe-C phase diagram

Mechanical properties of Grey Cast Iron

- comparatively weak and brittle in tension
- Tips of graphite flakes are sharp and pointed which may serve as points of stress concentration when an external tensile stress is applied.
- Strength and ductility are much higher under compressive loads.
- High damping capacity (adsorb vibrational energy) → Base structures for machines and heavy equipment.
- high resistance to wear.
- In the molten state, have a high fluidity at casting temperature, which permits casting pieces having intricate shapes; also, casting shrinkage is low.
- least expensive of all metallic materials.
- Different type of microstructures → adjustment of composition and/or by using an appropriate heat treatment. (Si↓ and cooling rate↑ give graphite flakes in pearlite matrix)

Heat treatment of Grey Cast Iron

- Stress relieving
- Annealing
- Normalizing
- Hardening and tempering

Stress Relieving

- Relieve residual stress introduced during solidification
- Temperature $< A_{c1}$ temperature (538 to 568°C)
- Temperature \uparrow es \rightarrow % of residual stress removal \uparrow es

Annealing:

- To improve the machinability by minimizing or eliminating massive eutectic carbides.
- Types:
 - Ferritizing annealing
 - Low alloy content
 - Cementite in pearlite \rightarrow ferrite + graphite
 - $760 > T > 590^\circ\text{C}$
 - Full annealing
 - High alloy content
 - Carbide \rightarrow alloy + graphite
 - $790 > T > 900^\circ\text{C}$
 - Graphitizing annealing
 - Massive iron carbide \rightarrow pearlite + graphite
 - $900 > T > 955^\circ\text{C}$
 - $T > 925^\circ\text{C}$ Fe₃P will melt. Since holding time should be less

-

- Improve TS and hardness
- $T=885-925^{\circ}\text{C}$

Hardening and Tempering:

- To improve strength and wear resistance

Stainless Steels

- ❑ Stainless Steels are a large group of special alloys developed primarily to withstand corrosion. These steels contain chromium in excess of 12% by weight which imparts “stainless” characteristics to iron alloys.
- ❑ Classification :

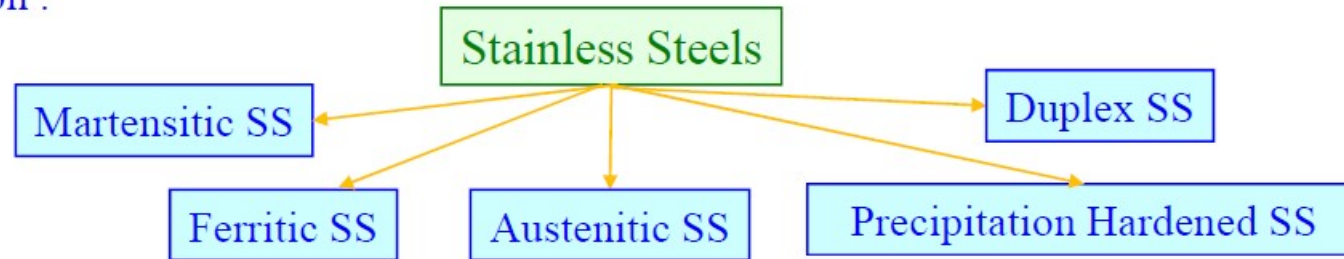

- ❑ AISI Grades of stainless steels

Series Designation	Groups
2xx	Chromium-Nickel-Manganese; Nonhardenable, Austenitic, Nonmagnetic
3xx	Chromium-Nickel; Nonhardenable, Austenitic, Nonmagnetic
4xx	Chromium; Hardenable, Martensitic, Magnetic
4xx	Chromium; Nonhardenable, Ferritic, Magnetic
5xx	Chromium; Low chromium; Heat-Resisting

Defects, Causes and Remedies in Heat Treatment

Desired properties are not achieved in HT due to

- Wrong selection of material
- Inherent defect in the material
- Improper design of a tool/machine
- Wrong selection of HT process

Common HT defects:

- Low hardness and strength after hardening
- Soft spots
- Oxidation and decarburization
- Over heating and burning
- Formation of cracks
- Distortion and warping

Distortion and Warping

- Distortion: the change in size and shape of heat treated component due to thermal and structural stress
- Warping: Asymmetrical distortion of component after heat treatment
- Following dimensional changes occur in the heat treatment
 - Thermal expansion till AC_1
 - Contraction on transformation to austenite
 - Thermal expansion of austenite on further heating
 - Thermal contraction on cooling to the transformation temperature
 - Expansion on diffusional or diffusionless decomposition of austenite
 - Thermal contraction on further cooling to room temperature
 - Contraction on tempering of martensite
- Cause for warping:
 - Presence of residual stresses,
 - Sagging
 - Formation of thermal and structural stresses during heating and quenching
 - Sharp variation in a section of the steel

- Cause for distortion
 - Rate of heating / cooling
 - Shape
 - Size
 - Wall thickness and geometry of the part
 - Chemical inhomogeneties
 - Structural inhomogeneties
 - Sub-zero treatment
- Remedies
 - Stress relieving annealing before HT cycle to reduce residual stresses due to previous machining or forging operation.
 - Preheating before heating cycle
 - Slow heating and slow cooling
 - Selection of quenchant
 - Trays, fixtures and supports for unsymmetrical sizes
 - Maintaining chemical and structural homogeneities
 - Treatment for stabilizing dimensions

Low hardness and strength after hardening

Causes

- Lower hardening temperature
- Insufficient soaking time
- Delayed quenching
- Slower cooling rates
- Presence of large amount of retained austenite

Remedies

- Proper selection of hardening temperature, soaking time and cooling rate
- Avoid delayed quenching
- To avoid RA, go for subzero treatment

Soft Spots

- After hardening, hardness on the surface of the component is not uniform. Hardened steels show varying hardness at different points on their surface → soft spots
- Causes:
 - Formation of vapour blanket b/w quenchant and component
 - Localized decarburization
 - In-homogeneity of microstructure
 - Presence of foreign matters such as dirt and sticky scales on the surface
 - Keeping a large components in furnace
 - Improper handling of component during quenching
- Remedy:
 - Adoption of spray quenching

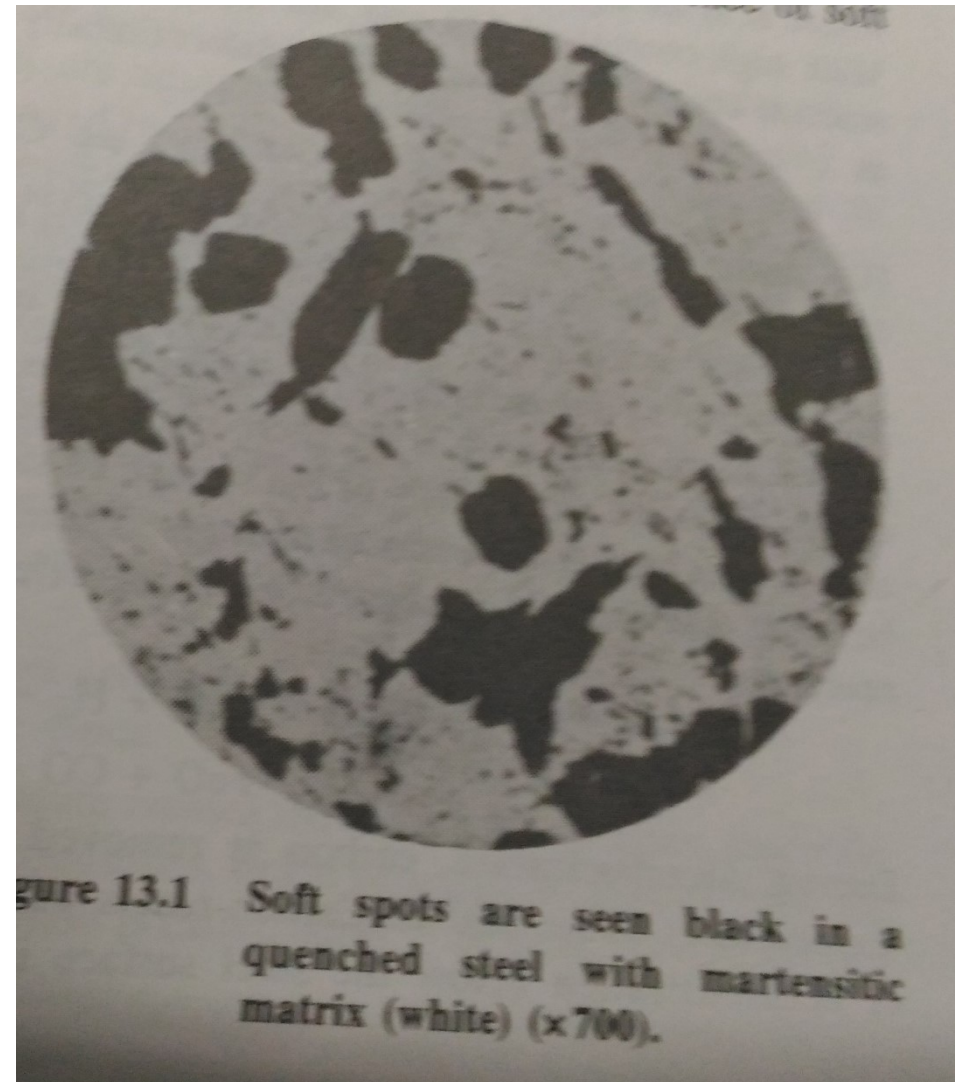

Figure 13.1 Soft spots are seen black in a quenched steel with martensitic matrix (white) ($\times 700$).

Overheating and burning of steel

- When steel heated above upper critical temperature → coarsening of austenitic grains → affect mechanical properties
- When steel heated near solidus temperature, liquation takes place at grain boundary which gives way for oxidation on the surface along the gb. → burning
- Burning is permanent. Then steel becomes a scrap.
- Problems:
 - Loss of ductility and toughness
 - Connecting rods or gears undergo premature failure due to fatigue
 - Presence of sulphide inclusions segregate along austenite grain boundary (creates extensive damage)
 - Coarse grained structure formation
 - Coarse of martensite formation
 - Surface decarburization and scaling

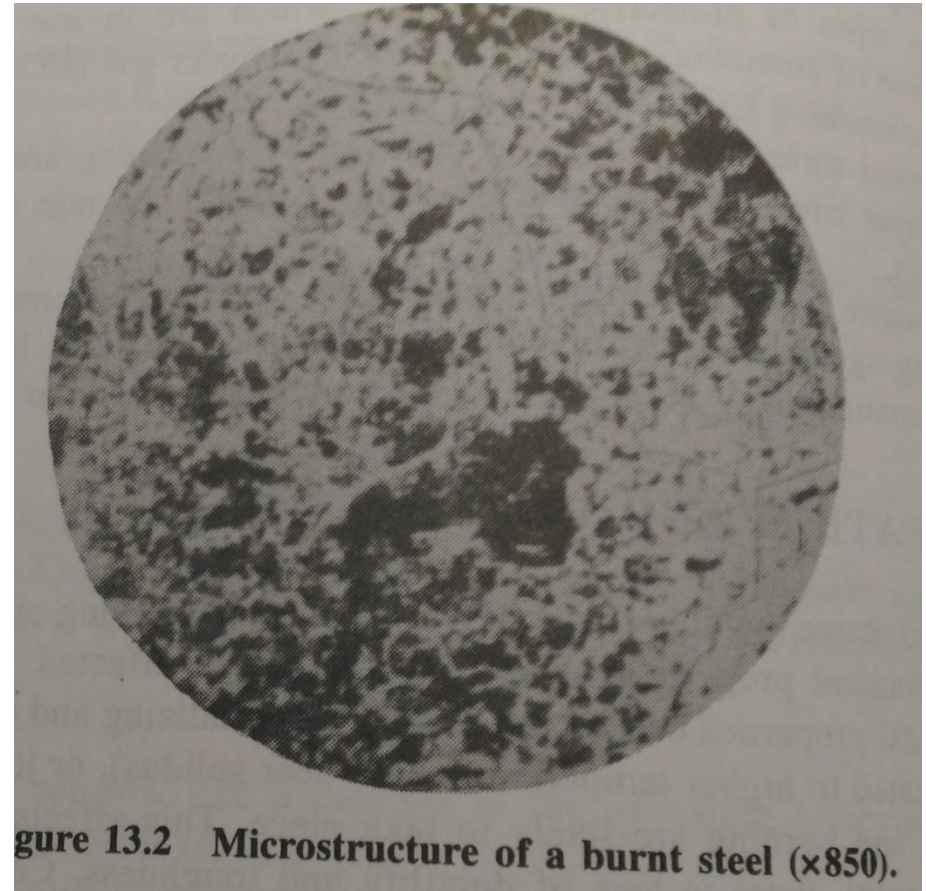

Figure 13.2 Microstructure of a burnt steel (×850).

- Causes:
 - Steel heated above a certain minimum temperature. (High carbon, low alloy and high alloy steels more susceptible to overheating)
 - When temperature is close to solidus temperature
 - Basic electric steels are more susceptible to overheating and burning than steels manufactured by open hearth process.
 - When steels are subjected to heating or forging, overheating temperatures are raised by 100°C
 - Steels with higher inclusion content have higher overheating temperatures. Segregation of P and S near grain boundaries.

- Remedies:
 - Selection of proper temperature
 - Know about the method the steels are produced
 - S and P lower the solidus and liquids temperature which is kept minimum
 - Less severely over heated steels can be recovered by
 - Repeated normalizing (6 times)
 - Repeated oil hardening and tempering treatments

Quench Cracks

- Cracks are formed in steel during phase transformation of austenite into martensite
- Causes:
 - Austenite → martensite (volume increases → induce compressive stress → leads to cracks)
 - Cooling rates differ in case and core
 - Residual stress due to temperature gradient
- Remedies:
 - Addition of alloying element, shift nose of the CCT curve to right hand, which reduce the cooling rate require for martensite formation
 - Removal of residual stress by tempering

Oxidation and Decarburization

- When steel is heated in the furnace open atmosphere, it undergoes oxidation and decarburization.

- The reaction for oxidation are,

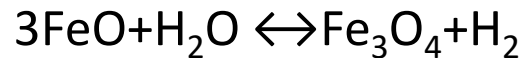
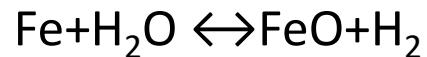
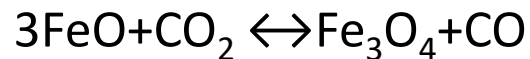
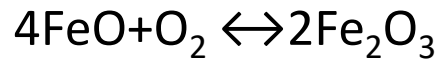
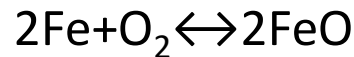

- CO, CO₂, H₂ and H₂O are also react among themselves

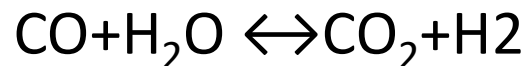

Tool Steel

- Tool steel refers to a variety of carbon and alloy steels that are particularly well-suited to be made into tools.
- Characteristics include high hardness, resistance to abrasion (excellent wear), an ability to hold a cutting edge, resistance to deformation at elevated temperatures (red-hardness).
- Tool steel are generally used in a heat-treated state.
- Carbon content → 0.1 -1.6% . Alloying elements → Cr, Mo, V, W etc.
- Applications: Blanking, die forging, forming, extrusion and plastic molding etc..

Types of Tool Steels

AISI-SAE tool steel grades		
Defining property	AISI-SAE grade	Significant characteristics
Water-hardening	W	
Cold-working	O	Oil-hardening
	A	Air-hardening; medium alloy
	D	High carbon; high chromium
Shock resisting	S	
High speed	T	Tungsten base
	M	Molybdenum base
Hot-working	H	H1-H19: chromium base H20-H39: tungsten base H40-H59: molybdenum base
Plastic mold	P	
Special purpose	L	Low alloy
	F	Carbon tungsten

Tools and Its Properties

- Shock resisting tool steels → Intended for applications requiring toughness and resistance to shock-loading such as hammers, chisels, punches, driver bits and others.
- Water hardening tool steels → Shallow hardened and relatively low resistance to softening. They are suitable for woodworking tools, hand-metal cutting tools such as taps and reamers and cutlery.

Steels for Room Temperature Use (Classified according to their quenching media)

- **Water hardened grades (W)** → Plain carbon steels with 0.6-1.0 %C. These have a low hardenability, i.e., martensite only to a depth of 0.5 in. **V** can be added (forms V_4C_3) to improve the hardness and wear resistance of these steels.
- **Shock resistant grades (S)** → Contain small amounts of **Cr or Mo** and are quenched in oil. They have lower C contents (0.5%) to improve impact strength.
- **Oil hardened grades (O)** → Small percentages of **Cr and W** with 0.9 %C. They have medium hardness and are used to short run cold forming dies.
- **Air hardening grades (A)** → Greater amounts of **Cr and Mo** and 1 %C. Used for complicated shapes and thread rolling. Mo and W are relatively expensive so they add only in small amounts to give much improved hardenability.
- **High carbon, high Cr grades (D grade)** → **12 %Cr and 1.5-2.25 %C** are extremely wear resistant and used for long run dies and for gauges. Chromium is a relatively low cost addition for increasing hardenability with the excess Cr, $Cr_{23}C_6$ is also formed, which improves wear resistance.

SHOCK-RESISTING TOOL STEELS

- Carbon content = 0.5-0.6%. Alloying elements – Cr, W , Mo.
- Properties: good toughness, hardness and improved hardenability. These steels are generally, water or oil-hardened.
- “Low temperature Tempering” is carried out where, toughness and hardness of the tool steel are of prime importance, otherwise “High temperature Tempering” is preferred.
- Silicon-manganese steels (0.55% C, 2.0% Si, 1.0 % Mn) are included in this group. Due to their high Si-content, decarburization and grain coarsening takes place in these type of steels.

- HEAT TREATMENT PROCEDURE (in general) :-
 - **Annealing** : Slow & uniform heating in the range of 790-800°C followed by furnace cooling at rate of 8-15°C/hr.
 - **Stress relieving** : Heat to 650- 675°C and furnace cooling.
 - **Hardening** :
 - Preheating – warming to about 650°C & holding for 20 minutes/ 25mm.
 - Austenitizing – heating to 900-950°C & holding again for 20minutes/25mm.
 - Tempering** : Heating to 205-650°C, holding for 30 minutes/25mm and then, air cooling.

- Applications:
 - Chisels
 - Pneumatic chisels
 - Punches
 - Shear blades
 - Scarring Tools
 - River sets
 - Driver bits.

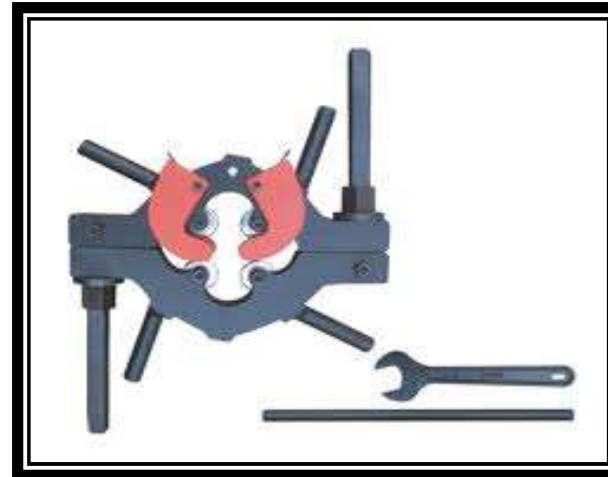

ROTARY PIPE CUTTER

GOLD SET MAGNETIC NUT SETTER



SWANSTORM DISC CUTTER

MARAGING STEEL

- Maraging Steels are ultrahigh strength steels based on Fe-Ni system.
- They derive their excellent properties due to combination of two solid state reactions: **MAR + AGEING**
 ⇒ Meaning, Martensitic transformation in Fe-Ni system and its subsequent ageing.
- Fe-Ni martensite serves as an excellent host for a number of alloying elements which strengthen the steel on subsequent ageing.

Excellent Mechanical Properties	Good Processing and Fabrication Characteristics	Simple Heat Treatment
1. High strength and high strength-to-weight ratio. 2. High plane strain fracture toughness. 3. High notch toughness 4. Maintains high strength up to at least 350°C.	1. Very good Hot and cold formability. 2. Work-hardening rates are low. 3. Excellent weldability, either in the annealed or aged condition. 4. Good machinability.	1. No quenching required. Softened and solution treated by air cooling from 820-900°C. 2. Hardened and strengthened by ageing at 450-500°C. 3. No decarburization effects 4. Dimensional changes during age hardening are very small – possible to finish machine before hardening. 5. Can be surface hardened by nitriding.



**Microstructure produced by annealing
1 hr at 800°C; 100% bcc phase**

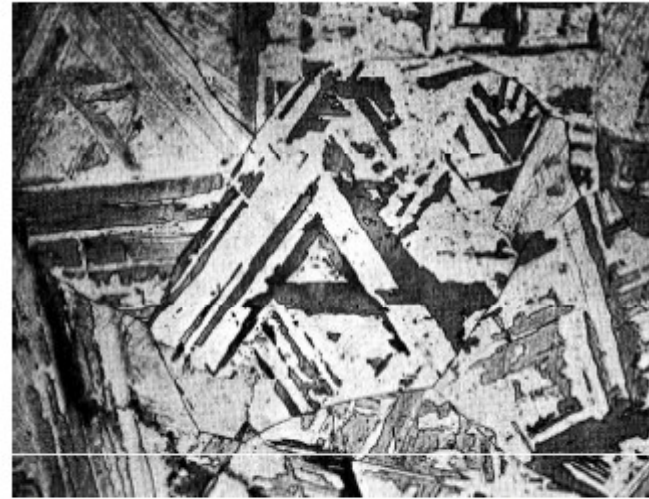

**Microstructure produced by Annealing
1 hr at 1240°C; 100% bcc phase.**

Heat Treatment of Maraging Steel

- Solutionizing: at 820°C, 1 hr
- Quenching: Air medium due to alloying elements
- Ageing: at 480°C for 3-4 hrs.
- Advantages:
 - Overageing is very slow even take more than 100 hrs.
 - Absence of retained austenite further ensures that there is no dimensional change in service.
 - During maraging treatment, a very small uniform contraction occurs.
 - contains very low carbon there is no decarburisation in these steels while heat treating.

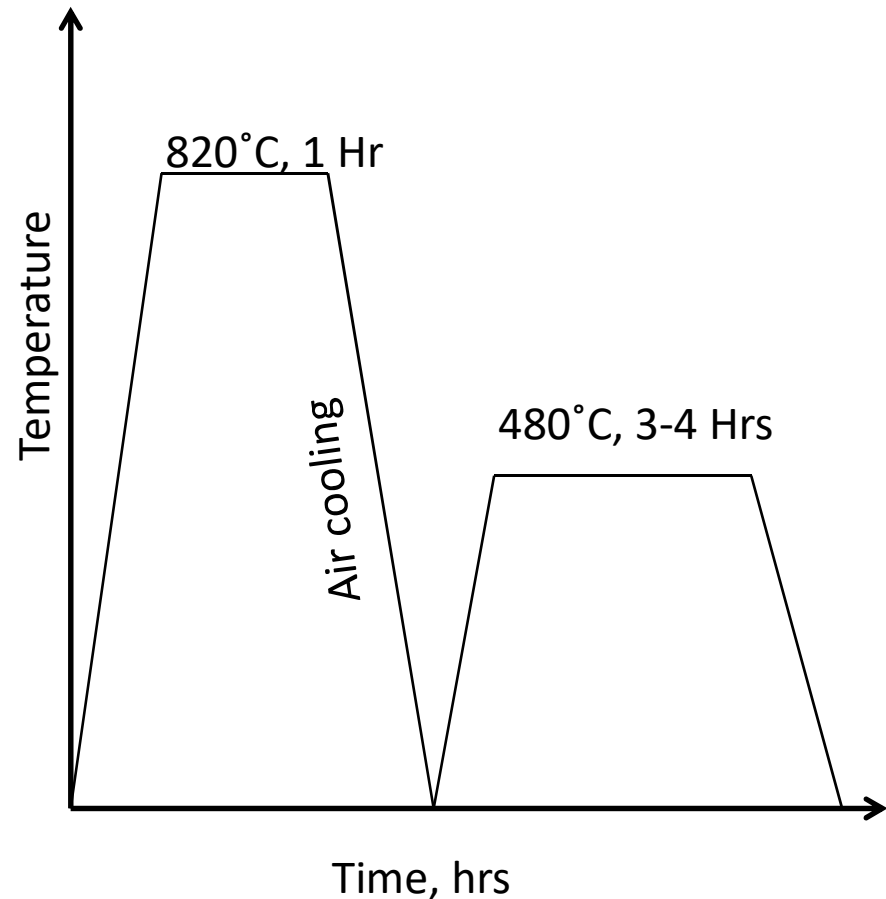

High Strength Low Alloy Steel

- A general description of HSLA steel is as that containing:
 - low carbon (0.03–0.25%) content to obtain good toughness, formability, and weldability,
 - one or more of the strong carbide-forming microalloying elements (MAEs) (e.g., V, Nb, or Ti),
 - a group of **solid solution strengthening** elements (e.g., Mn up to 2.0% and Si), and
 - one or more of the additional MAEs (e.g., Ca, Zr) and the rare earth elements, particularly Ce and La, for sulfide inclusion shape control and increasing toughness.
- In many other HSLA steels, small amounts of Ni, Cr, Cu, and particularly Mo are also present, which **increase atmospheric corrosion resistance and hardenability**.
- A very fine ferrite grain structure in the final product produced by a combination of controlled rolling and controlled cooling with an optimum utilization of microalloying additions, in HSLA steels, is an important factor **in simultaneously increasing strength and toughness and decreasing the ductile–brittle transition temperature (to as low as -70°C)**.

- Carbides (NbC, VC, TiC), nitrides (TiN, NbN, AlN), and carbo-nitrides (e.g., V(C,N), Nb(C,N), (Nb,V) CN, (Nb,Ti) CN) are the **dispersed second-phase particles** that act as grain size refiners or dispersive strengthening phases in HSLA steels.
- HSL A steels are successfully used as ship, plate , bar, structural sections, and forged bar products, and find applications in several diverse fields such as oil and gas pipelines; in the automotive, agricultural, and pressure vessel industries, in offshore structures and platforms and in the constructions of crane, bridges , buildings, ship buildings, railroad , tank cars, and power transmission and TV towers.

Classification of HSLA Steel

- **Weathering steels:** Steels containing $\sim 0.1\%$ C, $0.2\text{--}0.5\%$ Cu, $0.5\text{--}1.0\%$ Mn, $0.05\text{--}0.15\%$ P, $0.15\text{--}0.90\%$ Si, and sometimes containing Cr and Ni, exhibiting **superior atmospheric corrosion resistance**. Typical applications include railroad cars, bridges, and unpainted buildings.
- **Control-rolled steels:** Steels designated to develop a highly deformed austenite structure by hot rolling (according to a predetermined rolling schedule) that will transform to a **very fine equiaxed ferrite structure** on cooling .
- **Pearlite-reduced steels :** Steels strengthened by very fine-grained ferrite and precipitation hardening but with low carbon content , and therefore exhibiting little or no pearlite in the microstructure.
- **Dual-Phase steels:** Steel comprising essentially fine dispersion of hard strong **martensite** but sometimes also **retained austenite** or even **bainite** in a soft and **fine-grained ferrite matrix**. The volume fraction of martensite is about 20–30%. Steels are characterized by continuous yielding (i.e., no yield point elongation), low yield stress (the YS/UTS ratio being around 0.50), high UTS, superior formability, and rapid initial work-hardening rate. Additionally, they possess greater resistance to onset of necking (i.e., plastic instability) in the uniaxial sheet material forming process to provide large uniform strain.

- **Microalloyed steel:** Conventional HSLA steels containing V, Ti, or Nb, as defined above. They exhibit discontinuous yielding behaviour.
- **Accicular Ferrite Steels:** Very low -carbon (typically 0.03–0.06%) steels with enough hardenability (by Mn, Mo , Nb , and B additions) to transform on cooling to a very fine, high-strength acicular ferrite structure rather than the usual polygonal ferrite structure. In addition to high strength and good toughness , these steels have continuous yielding behavior.
- **Low carbon bainite steels:** Steels are strengthened by bainite, with very fine grains and precipitations. They contain Low carbon bainite steels 0.02–0 .2% C, 0.6–1. 6% M n, 0.3–0. 6% Mo, and MAEs (such as V, Nb, Ti, and B), usually containing 0.4–0.7% Cr. The yield strength of these steels is higher than 490 M Pa, with good toughness.
- **Low Carbon Martensitic Steels:** Steels are strengthened by martensite with high hardenability (by addition of Mo, Mn , Cr, Nb, and B) and fine grains (by Nb addition). These steels contain 0.05–0.25%C, 1.5–2.0% Mn , 0.20–0.50 Mo, and MAEs (such as Nb, Ti, V, and B). Some steels containing small amounts of Ni, Cr, and Cu, after rolling or forging, and directly quenching and tempering attain a low -carbon martensite structure with high yield strength (760–1100 MPa), high toughness (CVN 50–130J), and superior fatigue strength.

Dual Phase Steel

- Dual-phase steels → fine dispersion of hard martensite particles in a continuous, soft, ductile ferrite matrix.
- Intercritical annealing of a ferritic-pearlitic microstructure in the $\alpha+\gamma$ two phase field. Followed by a sufficiently rapid cooling to enable the austenite to martensite transformation.
- Three basic approaches exist for the commercial production of dual phase steels
 - a) The as-hot-rolled, where the dual phase microstructure is developed during the conventional hot-rolling cycle by careful control of chemistry and processing conditions.
 - b) The continuous annealing approach, where hot-or cold rolled steel strip is uncoiled and annealed intercritically to produce the desired microstructure.
 - c) The batch- annealing, where hot or cold-rolled material is annealed in the coiled condition.

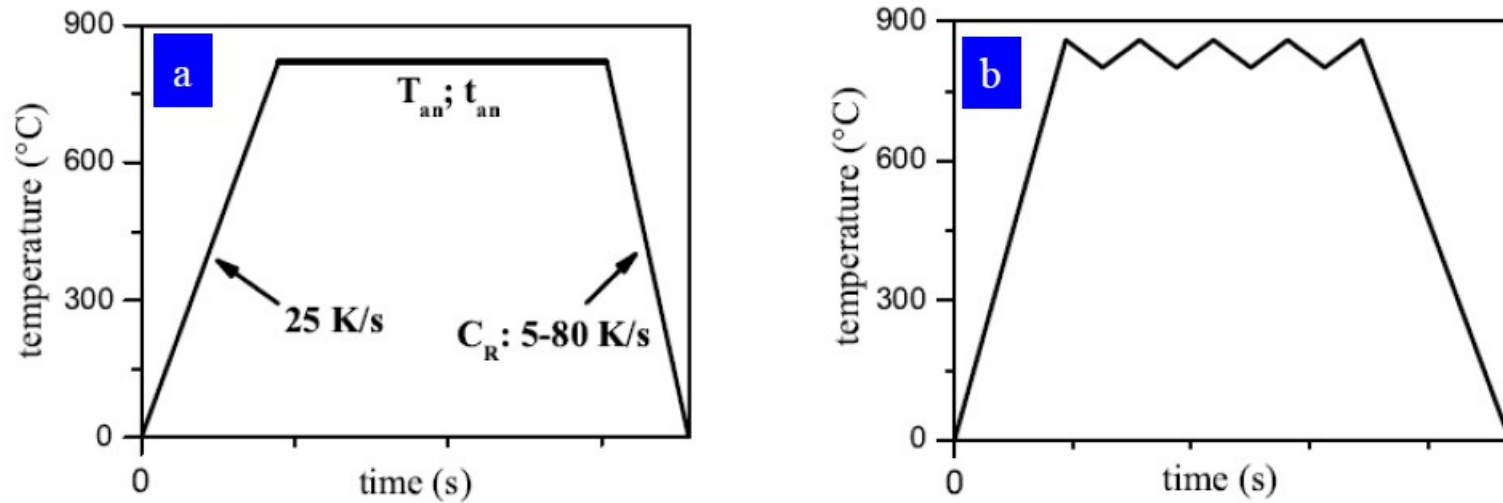

Figure : (a) Intercritical annealing, (b) Repeated heating cycles oscillating between the $\alpha+\gamma$ and γ phase fields

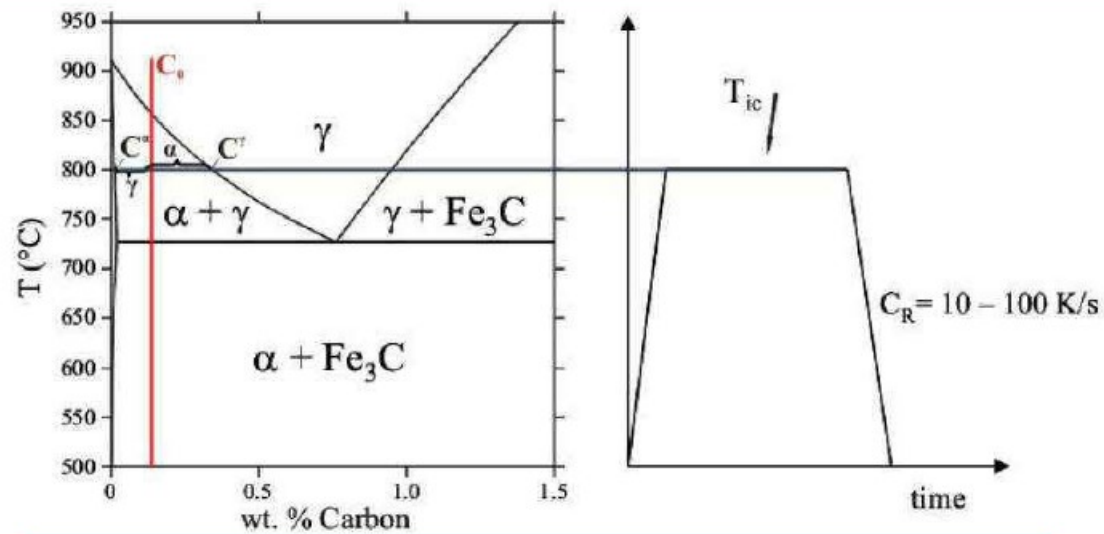
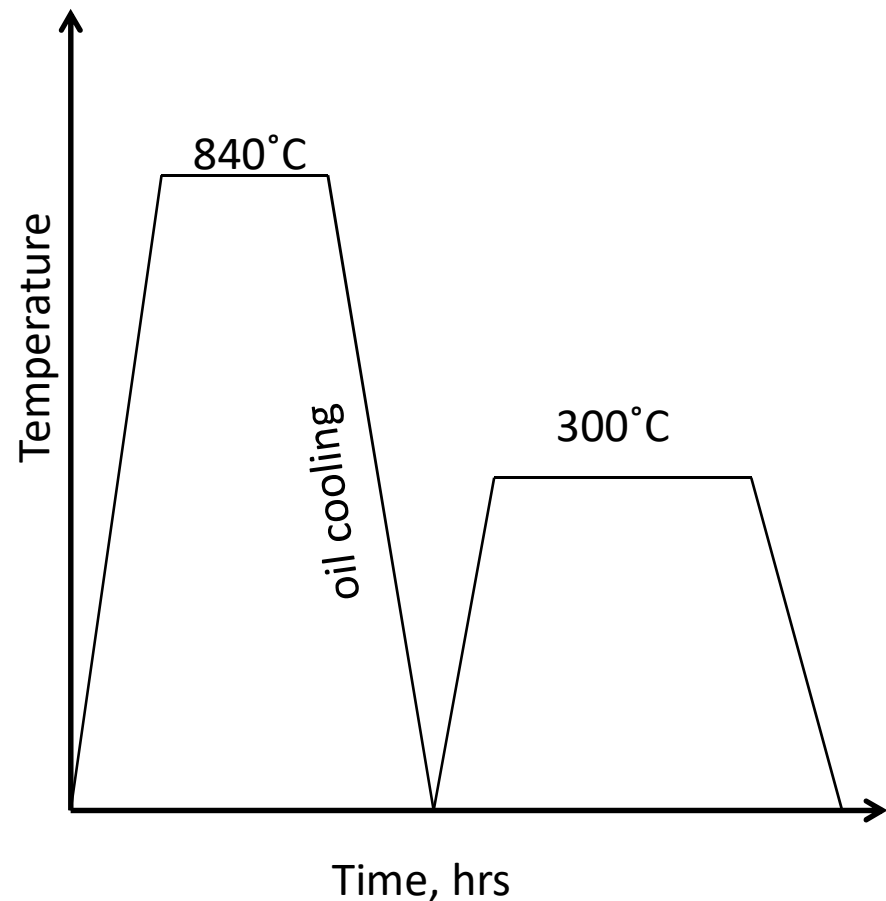

Figure : Production of dual phase steels by Intercritical annealing

Die Steel

- Die is at the heart of efficient extrusion production.
- Dies must withstand considerable amount of stresses, thermal shock, and oxidation.
- Dies are made from highly alloy tools steels or ceramics (zirconia, Si₃N₄). (for cold extrusion offering longer tool life and reduced lubricant used, good wear resistance).
- Heat treatments such as nitriding are required (several times) to increase hardness (1000-1100 Hv or 65-70 HRC). This improves die life.
- These steels typically undergo forging processes that are conducted around 1000 to 1100° C and are then annealed.

- Austenizing: at 840°C most of carbide dissolved in austenite phase except few like VC phase
- VC resist grain growth
- Presence of Mn reduce austenizing temperature. (Mn – austenite stabilizer) Since distortion is less.
- 1 % C 0.6 % Mn 0.25 % Si 5 % Cr 0.25 % V and 1 % Mo
- Presence of Mo and Cr raises the oxidation resistance and decarburization.



Classification of Al alloy

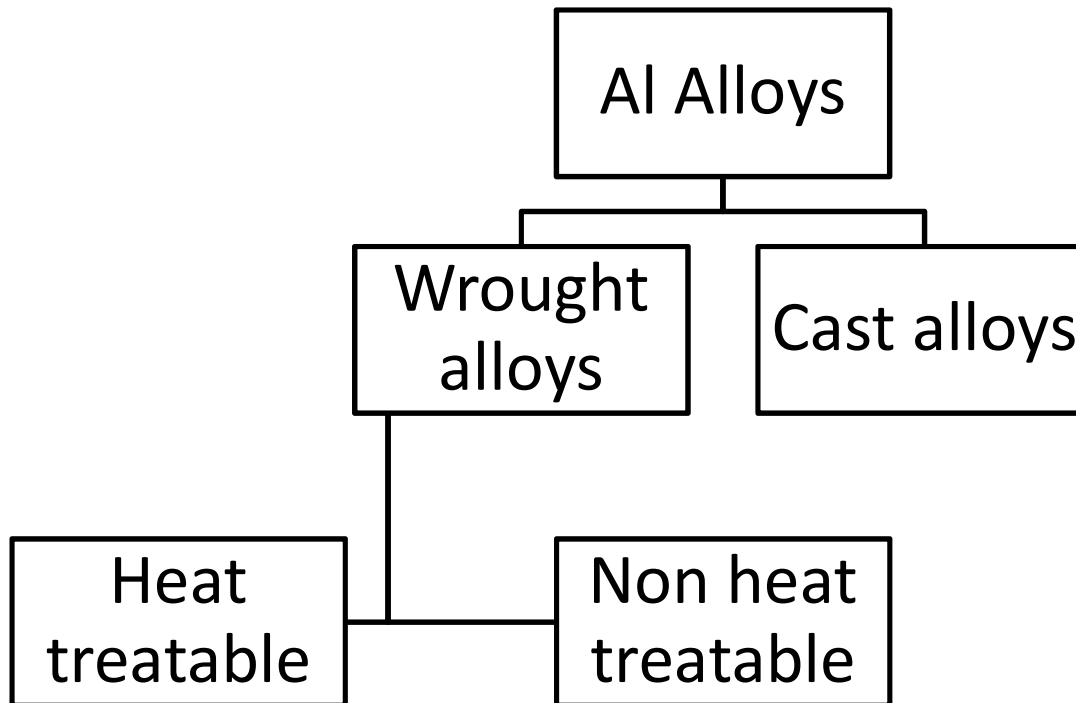

Designation of Wrought and Cast Alloys

Al alloy group	Wrought alloy	Cast alloys
Al \geq 99.0% purity 1XXX 1XX.X	1XXX	1XX.X
Al-Cu alloy	2XXX	2XX.X
Al-Mn alloy	3XXX	
Al-Si alloy	4XXX	4XX.X
Al-Mg alloy	5XXX	5XX.X
Al-Mg-Si alloy	6XXX	
Al-Zn and Al-Zn-Mg alloy	7XXX	7XX.X
Al with other element	8XXX	8XX.X (Sn)
Unused series	9XXX	

- The first digit indicates the alloy group.
- The second indicates modifications to alloy or impurity limit.
- The last two identify the aluminium alloy or indicates the aluminium purity.

Temper Designation

F – As fabricated

O – Annealed and
recrystallized

H - Strain-hardened

T – Heat treated

Strain Hardened Subdivisions

H1 – Strain hardened only

(H12 – quarter hard, H18 – full hard)

H2 – Strain hardened and partially
annealed

(Tempers are H22, H24, H26 and H28)

H3 – Strain hardened and stabilized

(H32, H34, H36 and H38)

Heat treated subdivisions

W Solution treated

T Age hardened

T1 – cooled from fabrication temp. and naturally aged

T2 – Cooled from fabrication temp., cold worked and naturally aged

T3 – solution treated, cold worked and naturally aged

T4 – solution treated and naturally aged

T5 – cooled from fabrication temp. and artificially aged

T6 – solution treated and artificially aged

T7 – Solution treated and stabilized by overaging

T8 – Solution treated, cold worked and artificially aged

T9 – Solution treated, artificially aged and cold worked

T10 – Cooled from the fabrication temperature, cold worked and artificially aged

Alloy identification systems

4-digit series	Aluminium content or main alloying elements
1 xxx	99.00% minimum
2 xxx	Copper
3 xxx	Manganese
4 xxx	Silicon
5 xxx	Magnesium
6 xxx	Magnesium and silicon
7 xxx	Zinc
8 xxx	Others

• The first digit indicates the alloy group.
 • The second indicates modifications to alloy or impurity limit.
 • The last two identify the aluminium alloy or indicates the aluminium purity.

Aluminium alloy and temper designation systems (IADS system)

Temper designations
(Added as suffix letters of digits to the alloy number)

Suffix letter F, O, H, T or W indicates basic treatment or condition.

First suffix digit indicates secondary treatment used to influence properties*

Second suffix digit for condition H only. Indicates residual hardening*

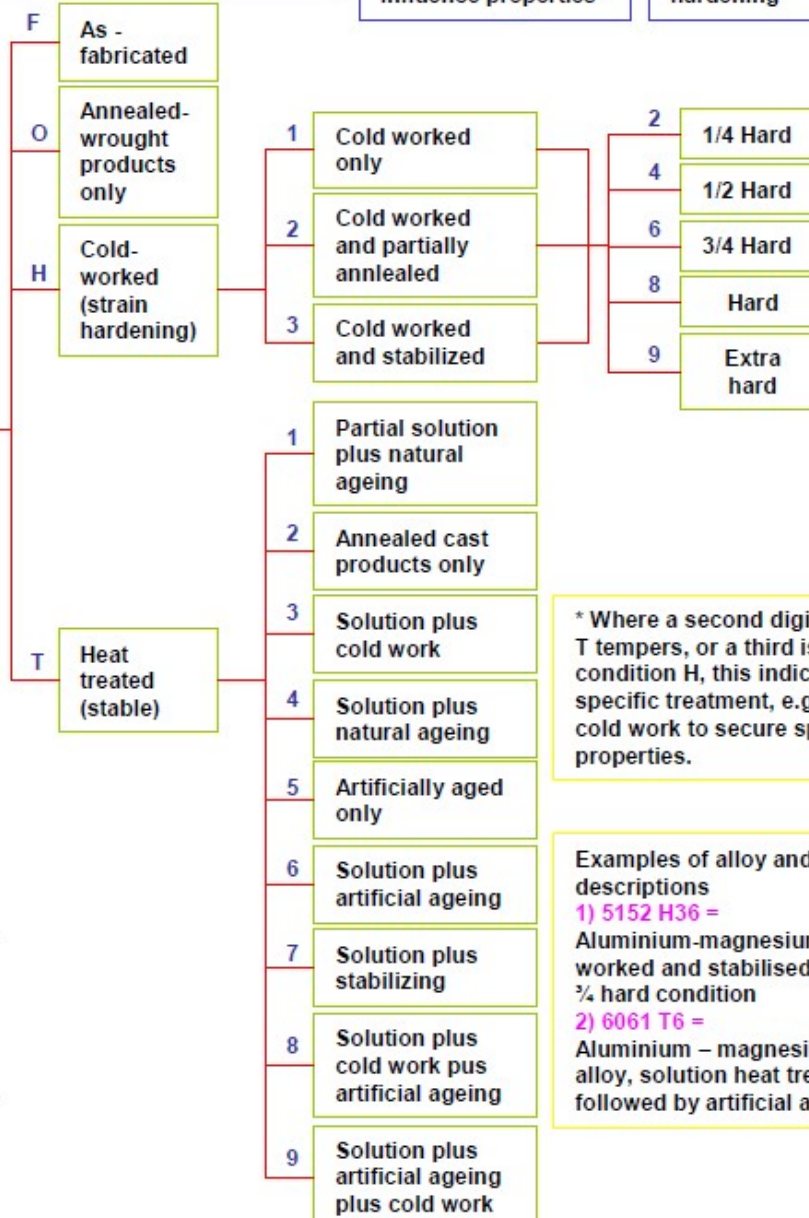

* Where a second digit is used for T tempers, or a third is used for condition H, this indicates a specific treatment, e.g. amount of cold work to secure specific properties.

Examples of alloy and temper descriptions
 1) 5152 H36 = Aluminium-magnesium alloy, cold worked and stabilised to develop a 3/4 hard condition
 2) 6061 T6 = Aluminium – magnesium – silicon alloy, solution heat treated followed by artificial ageing.

Heat Treatable Al alloys:

- Solid solubility decreases with decreasing temp.
- Forms coherent precipitates.
- Strength is improved by precipitation hardening
- Ex: 2XXX, 6XXX and 7XXX alloy series

Non Heat Treatable Al alloys:

- Do not form coherent precipitates.
- Strength is improved by solid solution strengthening
- Ex: 3XXX and 5XXX alloy series

Al-Cu system

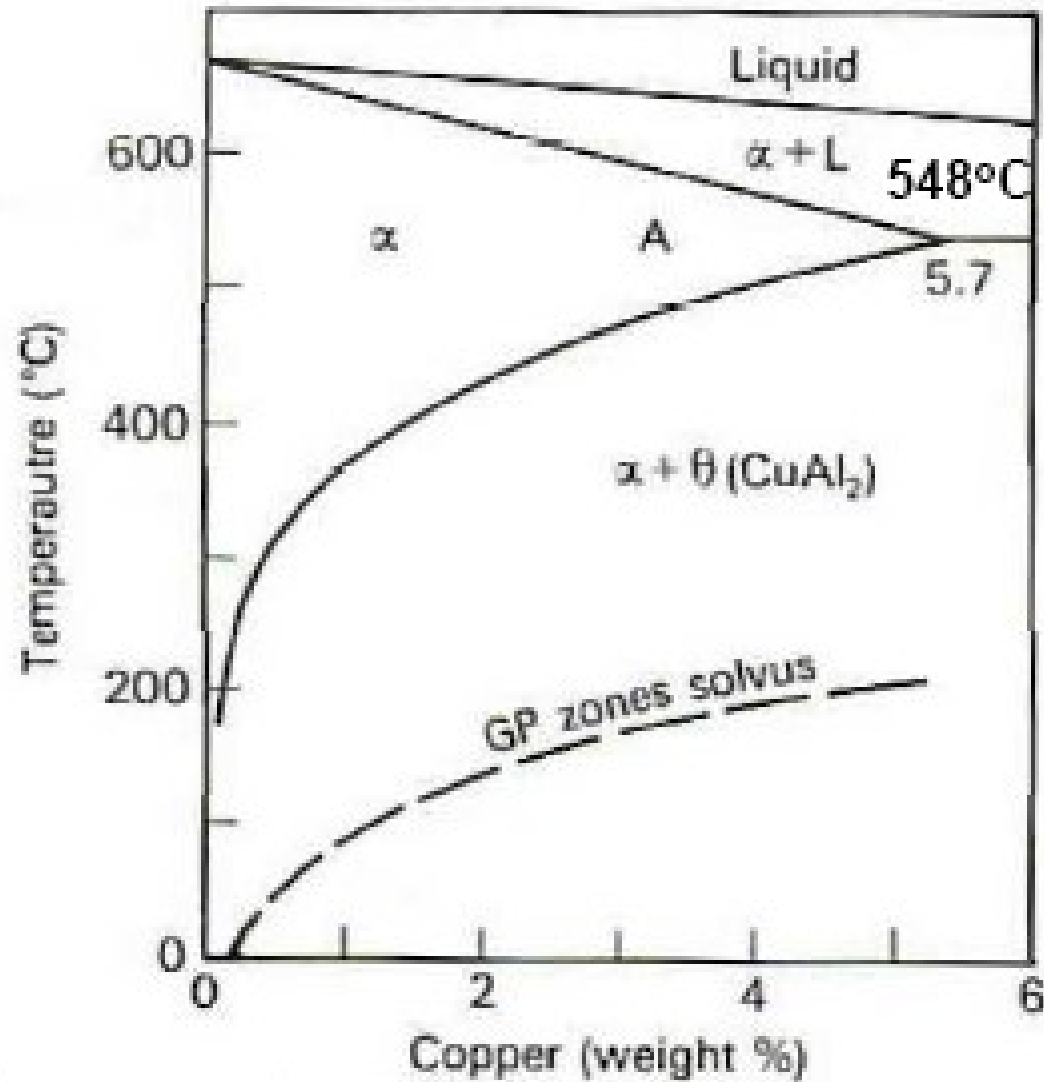

Precipitation Strengthening of Al-Cu alloy

- **Solution heat treatment:** The Al-4%Cu alloy first heated to about 515°C to form uniform solid solution α . This step is also called as **solutionizing**.
- **Quenching:** After the solutionizing, the alloy quenched to room temperature in water. This treatment produces a **supersaturated solid solution** (SSSS) of copper in aluminum.
- **Aging:**
 1. **Natural Aging:** Give sufficient time with out heating
 2. **Artificial Aging:** Heated between 130 to 190°C.

Due to the limited diffusion, very fine precipitate particles are obtained. The finely distributed particles effectively hinder the motion of dislocations in the Al matrix and increase the strength of the alloy.

Al-Cu system

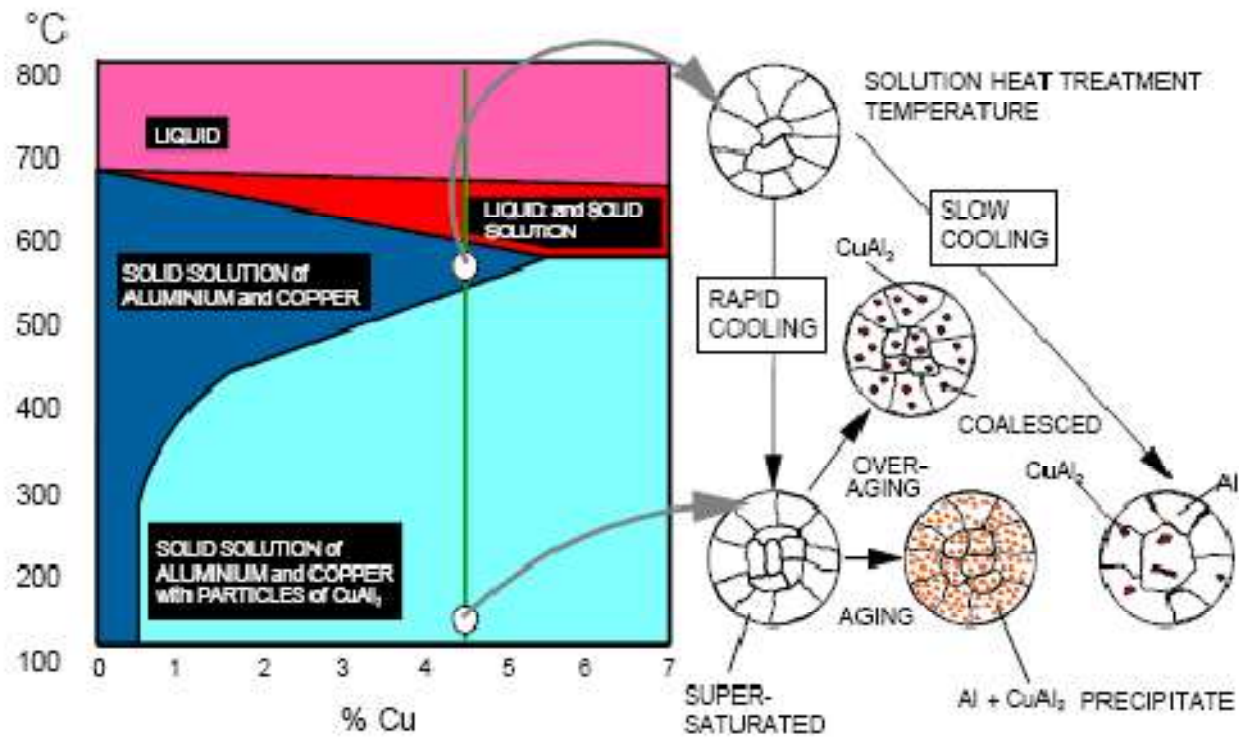

Al-Cu precipitation sequence

- In precipitation-strengthened Al-Cu alloys, four intermediated structure are identified:
 1. Gp_1 (Guiner – Preston) zones
 2. GP_2 zone (θ'')
 3. θ' and
 4. θ ($CuAl_2$)

Al-Cu precipitation sequence

- The sequence is:

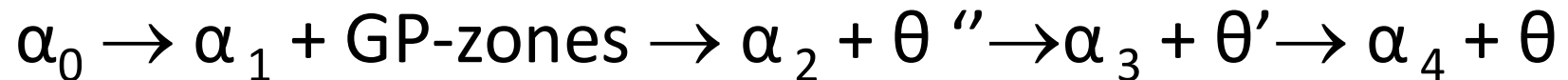

- The phase are:

α_n – fcc solid solution of aluminum; n^{th} subscript denotes each equilibrium

GP zones - mono-atomic layers of Cu on $(001)_{\text{Al}}$

θ'' - thin discs, fully coherent precipitate with matrix

θ' - disc-shaped, semi-coherent precipitate.

θ - incoherent interface, ~spherical, complex body-centered tetragonal (bct) precipitate.

Al-Cu ppt. structures

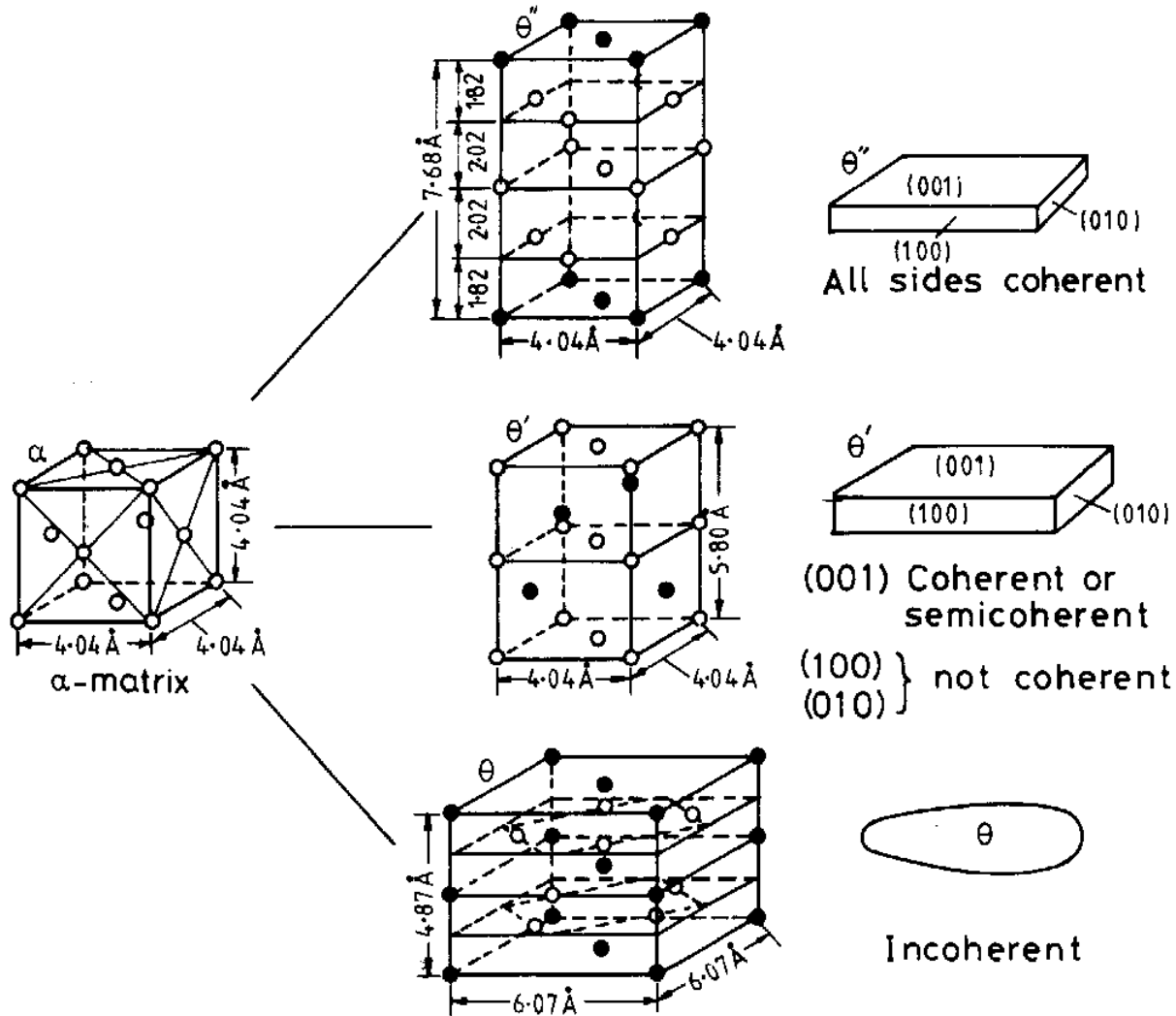

Fig. 5.29 Structure and morphology of θ'' , θ' and θ in Al-Cu (\circ Al, \bullet Cu).

Age Hardening Curves

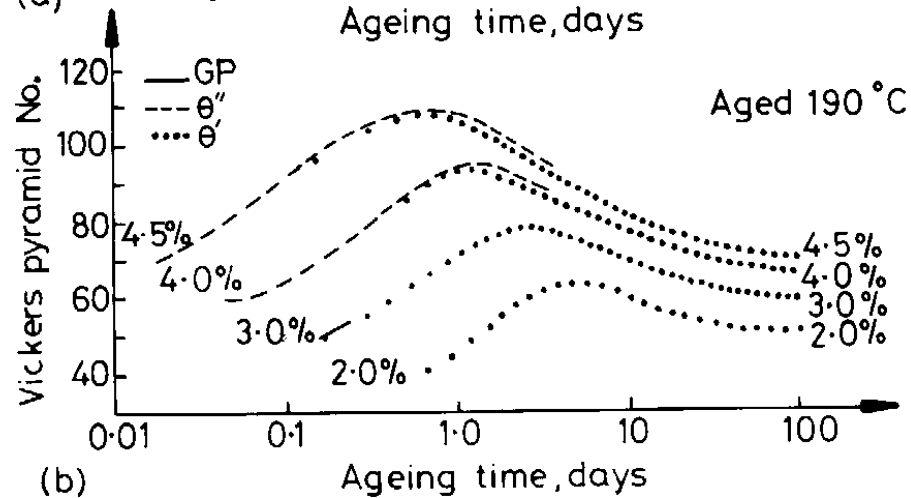
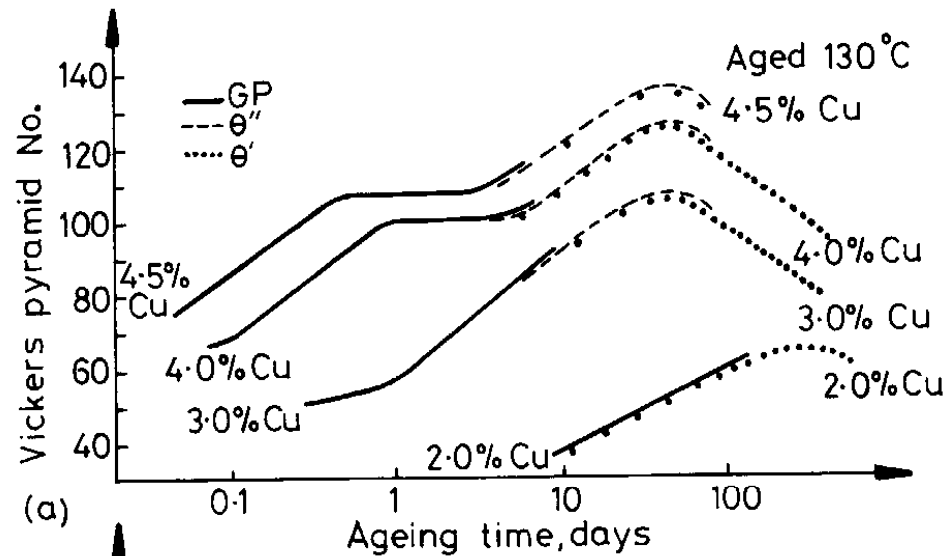
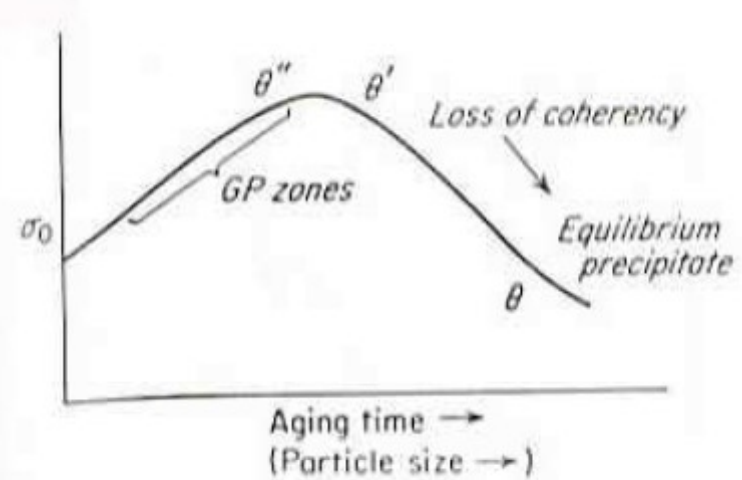

Fig. 5.37 Hardness v. time for various Al-Cu alloys at (a) 130 °C (b) 190 °C. (After J.M. Silcock, T.J. Heal and H.K. Hardy, *Journal of the Institute of Metals* 82 (1953-1954) 239.)



Overaging: . After the peak hardness, further aging tends to decrease the hardness.